

# VOGEL



**tesis**  
tecnologie e servizi industriali

# PROMO 2019/20

- **Servizio**
- **Prezzo**
- **Qualità**
- **Rapidità**

**Qualità**

Linearità Scala di lettura

**Planarità** RDT Geometria ISO

**Strumentazione** Problem Solving

Meccanica

**Risoluzione**

**Metrologia**

Planarità  
Controllo

**Idee**

Parallelismo



**Codici in rosso in esaurimento - Prezzi netti agli utilizzatori - IVA esclusa**

**Correzioni, modifiche e validità vedete il nostro sito [www.vogel.it](http://www.vogel.it)**

**Per tutti i prodotti non in promo è valido il listino 2019/20**

**Certificazioni  e rapporti di taratura vedere da pagina 73 a 79**



PAGINA 4/5



PAGINA 6



PAGINA 7/8



PAGINA 8/11



PAGINA 10



PAGINA 12



PAGINA 13



PAGINA 14/15



PAGINA 16



PAGINA 16/17



PAGINA 17



PAGINA 18/19



PAGINA 18/19



PAGINA 20/21



PAGINA 22



PAGINA 23



PAGINA 24



PAGINA 25



PAGINA 26



PAGINA 27/28



PAGINA 29

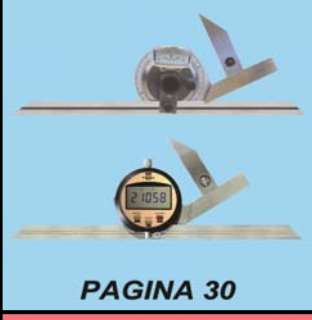

PAGINA 30



PAGINA 30



PAGINA 31



PAGINA 32/33



PAGINA 34



PAGINA 35



PAGINA 36



PAGINA 37



PAGINA 38/39



PAGINA 40/41



PAGINA 41



PAGINA 42



PAGINA 43



PAGINA 43



PAGINA 44/45



PAGINA 46



PAGINA 46



PAGINA 46



PAGINA 46/47



PAGINA 47

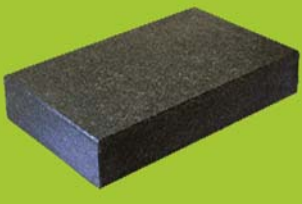

PAGINA 48

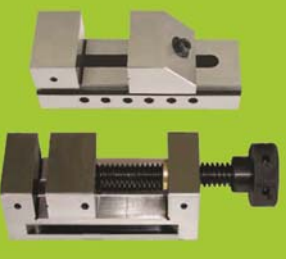

PAGINA 49



PAGINA 50



PAGINA 50



PAGINA 51



PAGINA 52

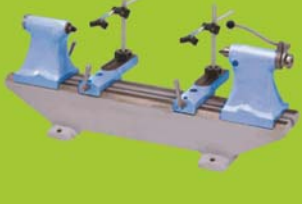

PAGINA 52



PAGINA 53



PAGINA 54



PAGINA 55



PAGINA 56



PAGINA 57



PAGINA 58



PAGINA 59



PAGINA 59



PAGINA 60



PAGINA 61



PAGINA 61



PAGINA 62



PAGINA 63



PAGINA 63



PAGINA 64



PAGINA 65/66



PAGINA 66/67



PAGINA 68



PAGINA 69/70



PAGINA 71



PAGINA 72

Certificazioni e Rapporti di taratura  
**ACCREDIA**  
L'ENTE ITALIANO DI ACCREDITAMENTO

PAGINA 73/79



Codice	Utile	Becchi	Letture	Prezzo €
001.108	150	40	0,05	13,00
001.110	200	50	0,05	20,50
001.112	300	60	0,05	35,50



Codice	Utile	Becchi	Letture	Prezzo €
001.102	150	40	0,05	13,50
001.105	200	50	0,05	21,00

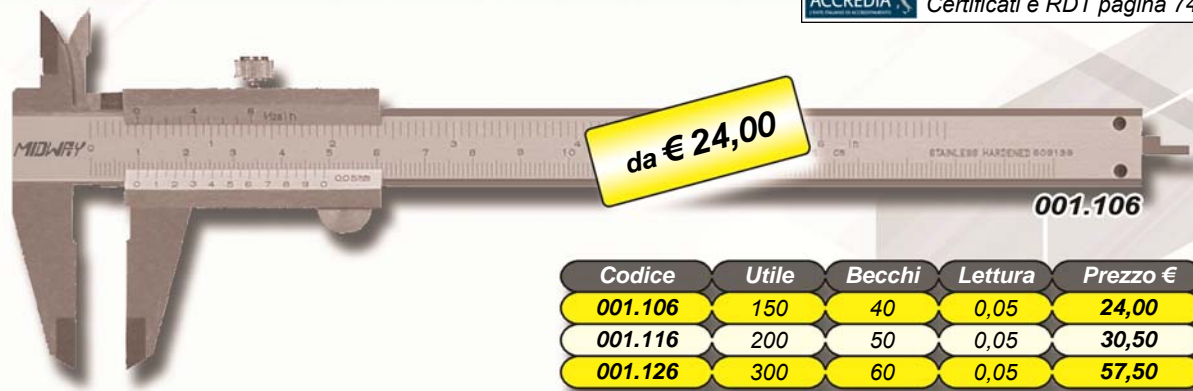

Codice	Utile	Becchi	Letture	Prezzo €
001.106	150	40	0,05	24,00
001.116	200	50	0,05	30,50
001.126	300	60	0,05	57,50



Codice	Utile	Becchi	Letture	Prezzo €
001.103	150	40	0,05	25,00
001.113	200	50	0,05	32,50
001.123	300	60	0,05	59,50

Calibri monoblocco Top 1/20° e 1/50° - Bloccaggio rapido a pulsante - Asta rettangolare

Catalogo 1/6

ACCREDIA Certificati e RTD pagina 74



da € 28,00

190.150

Codice	Utile	Becchi	Lettura	Prezzo €
190.150	150	40	0,05	28,00
190.155	150	40	0,02	30,00
190.200	200	50	0,05	43,00
190.300	300	60	0,05	74,00

Calibri monoblocco Top 1/20° e 1/50° - Bloccaggio a vite superiore - Asta rettangolare

Catalogo 1/6

ACCREDIA Certificati e RTD pagina 74



da € 28,00

191.150

Codice	Utile	Becchi	Lettura	Prezzo €
191.150	150	40	0,05	28,00
191.155	150	40	0,02	30,00
191.200	200	50	0,05	41,00
191.300	300	60	0,05	72,00

Calibri monoblocco 1/20° - Bloccaggio a vite sup. (106T) o pulsante (103T)- Asta tonda Ø2mm

Catalogo 1/7

ACCREDIA Certificati e RTD pagina 74

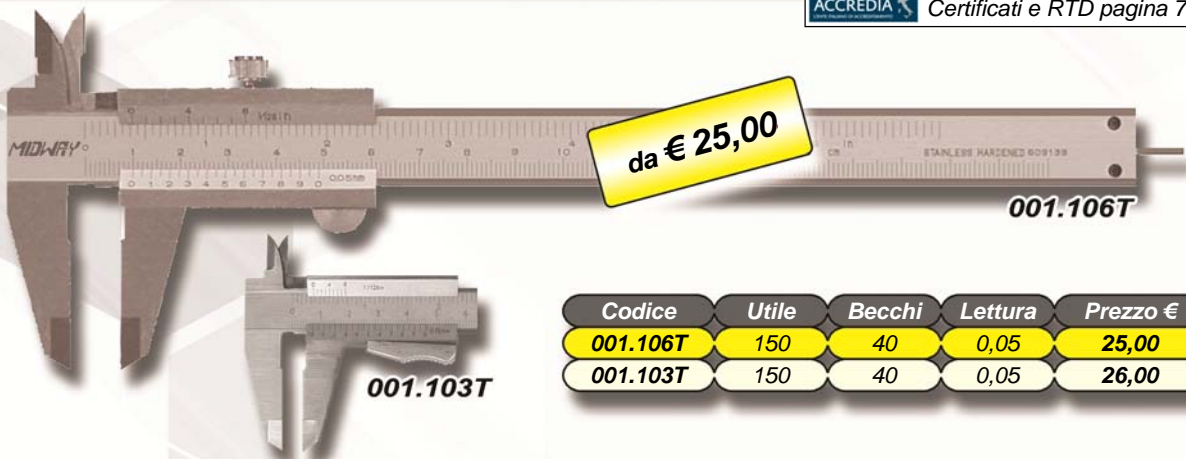

da € 25,00

001.106T

Codice	Utile	Becchi	Lettura	Prezzo €
001.106T	150	40	0,05	25,00
001.103T	150	40	0,05	26,00

Calibri monoblocco 1/20° - Bloccaggio a rotella

Catalogo 1/12

ACCREDIA Certificati e RTD pagina 74



€ 36,50

001.240

Codice	Utile	Becchi	Lettura	Prezzo €
001.240	150	40	0,05	36,50

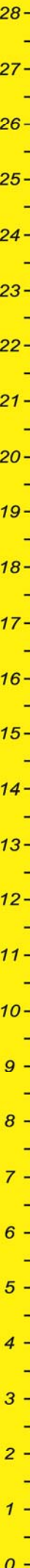

**Catalogo 1/13** Calibri ad orologio monoblocco 1/100° - Bloccaggio a vite - Rotella - Asta rettangolare nera

ACCREDIA Certificati e RDT pagina 74



Codice	Utile	Becchi	Letture	Prezzo €
218.501	150	40	0,01	58,00
218.502	200	50	0,01	74,00
218.503	300	60	0,01	136,00

**Catalogo 1/12** Calibri ad orologio monoblocco 1/50° - Bloccaggio a vite - Rotella - Asta rettangolare nera

ACCREDIA Certificati e RDT pagina 74



Codice	Utile	Becchi	Letture	Prezzo €
217.501	150	40	0,02	48,00
217.502	200	50	0,02	69,00
217.503	300	60	0,02	109,00

**Catalogo 1/13** Calibri ad orologio monoblocco 1/100° - Bloccaggio a vite - Senza rotella - Asta rettangolare

ACCREDIA Certificati e RDT pagina 74



Codice	Utile	Becchi	Letture	Prezzo €
213.500	150	40	0,01	48,00
213.504G	200	50	0,01	61,00

**Catalogo 1/13** Calibri ad orologio monoblocco 1/50° - Bloccaggio a vite - Senza rotella - Asta rettangolare

ACCREDIA Certificati e RDT pagina 74



Codice	Utile	Becchi	Letture	Prezzo €
213.501G	150	40	0,02	42,00
213.502G	200	50	0,02	58,00
213.503G	300	60	0,02	92,00

ACCREDIA Certificati e RTD pagina 74



Codice	Utile	Becchi	Lettura	Prezzo €
009.141	150	40	0,01	27,00
009.142	200	50	0,01	41,00

Calibri digitali - Asta nera - On/off - mm/inch - Zero - (009.158 per mancini)

Novità

ACCREDIA Certificati e RTD pagina 74



Codice	Utile	Becchi	Lettura	Prezzo €
009.186	150	40	0,01	23,00
009.158	150	40	0,01	66,00

Calibri digitali - Asta nera - On/off - mm/inch - Zero - Con rotella

Novità

ACCREDIA Certificati e RTD pagina 74



Codice	Utile	Becchi	Lettura	Prezzo €
009.184	150	40	0,01	25,50

Calibri con bloccaggio rapido a pulsante - Senza rotella - Asta rettangolare

Catalogo 1/18

ACCREDIA Certificati e RTD pagina 74



Codice	Utile	Becchi	Lettura	Prezzo €
009.091	150	40	0,01	53,00
009.092	200	50	0,01	72,00



Catalogo 1/14

Calibri digitali con cassa metallica - Rotella smontabile - Asta rettangolare

ACCREDIA Certificati e RTD pagina 74



009.031

Codice	Utile	Becchi	Letture	Prezzo €
009.031	150	40	0,01	36,50
009.032	200	50	0,01	65,50
009.033	300	60	0,01	89,50
Elettronica preset 009.031P	150	40	0,01	42,50

Elettronica preset

Catalogo 1/15

Calibri digitali con funzione ABS - Rotella smontabile - Asta rettangolare

ACCREDIA Certificati e RTD pagina 74



009.181

Codice	Utile	Becchi	Letture	Prezzo €
009.181	150	40	0,01	44,50
009.182	200	45	0,01	69,50
009.183	300	60	0,01	129,00

Catalogo 1/21

Calibri digitali con asta in vetro - Absolut System

ACCREDIA Certificati e RTD pagina 74



009.081

Codice	Utile	Becchi	Letture	Prezzo €
009.081	150	40	0,01	68,50
009.082	200	50	0,01	87,50
009.083	300	60	0,01	122,50

Catalogo 1/16

Calibri digitali in acciaio inox - Amagnetici

ACCREDIA Certificati e RTD pagina 74



009.045

Codice	Utile	Becchi	Letture	Prezzo €
009.045	150	40	0,01	93,00
009.046	200	50	0,01	125,00
009.047	300	60	0,01	187,00



Calibri digitali senza limite di velocità - Absolut System - Asta rettangolare - Cassa metallica

Catalogo 1/20

ACCREDIA Certificati e RTD pagina 74



Codice	Utile	Becchi	Lettura	Prezzo €
009.116	150	40	0,01	42,50
009.117	200	50	0,01	53,50
009.118	300	60	0,01	88,50

Calibri digitali Top con cassa metallica - Display XXL - Rotella - Asta rettangolare

Novità

ACCREDIA Certificati e RTD pagina 74

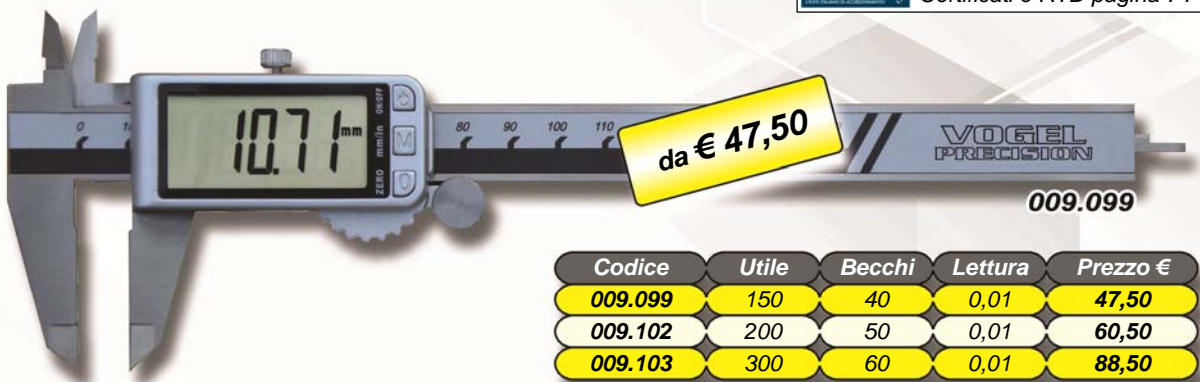

Codice	Utile	Becchi	Lettura	Prezzo €
009.099	150	40	0,01	47,50
009.102	200	50	0,01	60,50
009.103	300	60	0,01	88,50

Calibri digitali con encoder e cremagliera - IP67 - Bloccaggio a vite - Asta rettangolare

Catalogo 1/22

ACCREDIA Certificati e RTD pagina 74

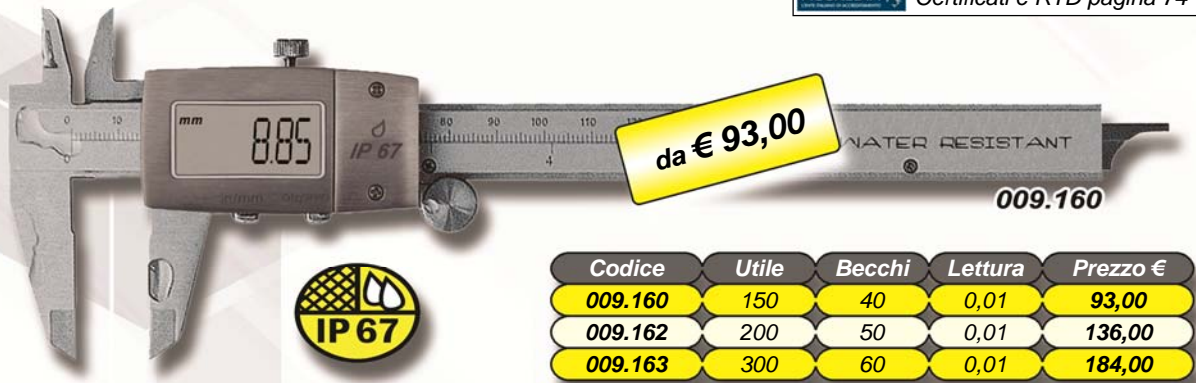

Codice	Utile	Becchi	Lettura	Prezzo €
009.160	150	40	0,01	93,00
009.162	200	50	0,01	136,00
009.163	300	60	0,01	184,00

Calibri digitali con becchi in metallo duro - Senza rotella - Asta rettangolare

Catalogo 1/16

ACCREDIA Certificati e RTD pagina 74



Codice	Utile	Becchi	Lettura	Prezzo €
009.048	150	40	0,01	65,00
009.049	200	50	0,01	97,50

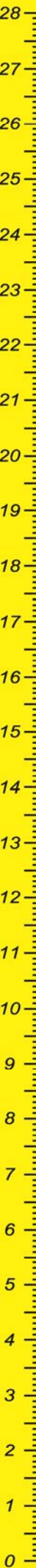

24mm

€ 131,00

009.714

Retro

Codice	Utile	Piedini	Letture	Prezzo €
009.714	3-140	4 x L3	0,01	131,00

da € 116,00

009.257

Codice	Utile	Becchi	Letture	Prezzo €
009.257	10-160	26	0,01	116,00
009.258	10-210	28	0,01	155,50
009.259	10-310	35	0,01	170,50

da € 145,00

009.709

Codice	Utile	Becchi	Spessore	Prezzo €
009.709	150	50	5+5	145,00
009.729	200	83	7+7	221,00

Disponibili anche con Bluetooth

da € 107,00

IP67

215.714

Codice	Utile	Becchi	Letture	Prezzo €
215.715	150	40	0,01	107,00
215.720	200	50	0,01	139,50
215.730	300	60	0,01	188,00
215.714	150	40	0,001	128,00

IP67

Millesimale

ACCREDIA Certificati e RTD pagina 74



Codice	Utile	Becchi	Letture	Prezzo €
215.515	150	40	0,01	94,00
215.520	200	50	0,01	127,00
215.530	300	60	0,01	185,00
215.516	150	40	0,01	99,00



Calibri digitali - IP67 - Guide lubrificate - Controllo di forza

Novità

Electronica Sylvac con uscita dati

ACCREDIA Certificati e RTD pagina 74



Codice	Utile	Becchi	Letture	Prezzo €
220.806	150	40	0,01	239,00



CONTROLLO DI FORZA - ottimale 8N

Calibri digitali lettura 0,005mm - IP67

Novità

ACCREDIA Certificati e RTD pagina 74

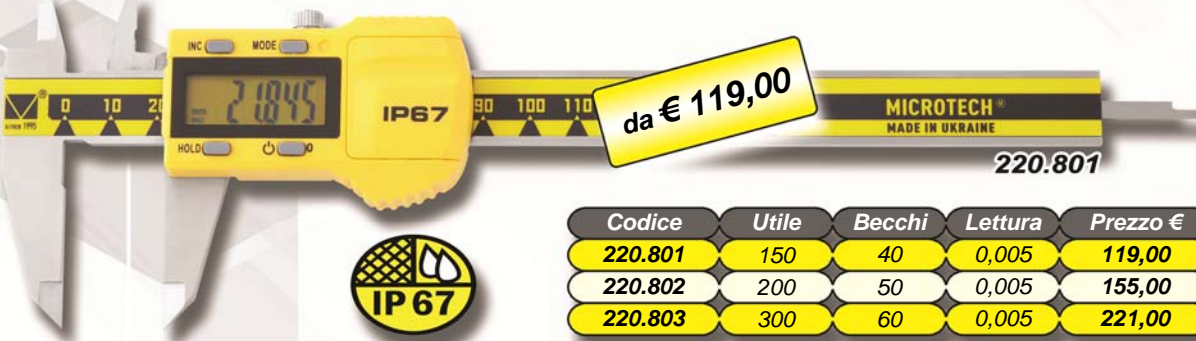

Codice	Utile	Becchi	Letture	Prezzo €
220.801	150	40	0,005	119,00
220.802	200	50	0,005	155,00
220.803	300	60	0,005	221,00



Calibri digitali auto-on - Bloccaggio a vite - Asta rettangolare - Electronica Sylvac con preset

Catalogo 1/23

ACCREDIA Certificati e RTD pagina 74

Electronica Sylvac con uscita dati



Codice	Utile	Becchi	Letture	Prezzo €
220.795	150	40	0,01	134,00
220.796	200	50	0,01	199,00
220.797	300	60	0,01	265,00

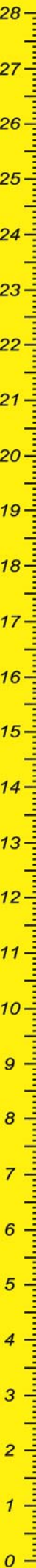

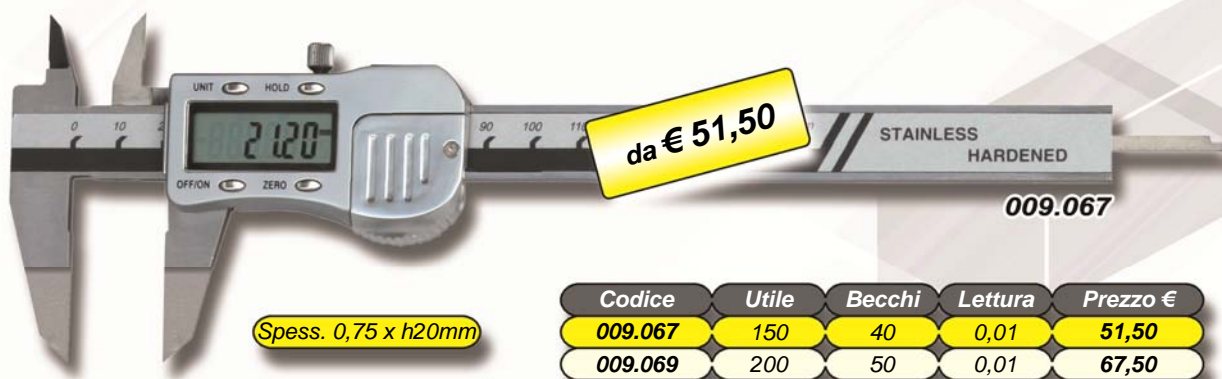

Codice	Utile	Becchi	Letture	Prezzo €
001.020	100	20	0,1-Lin	4,00

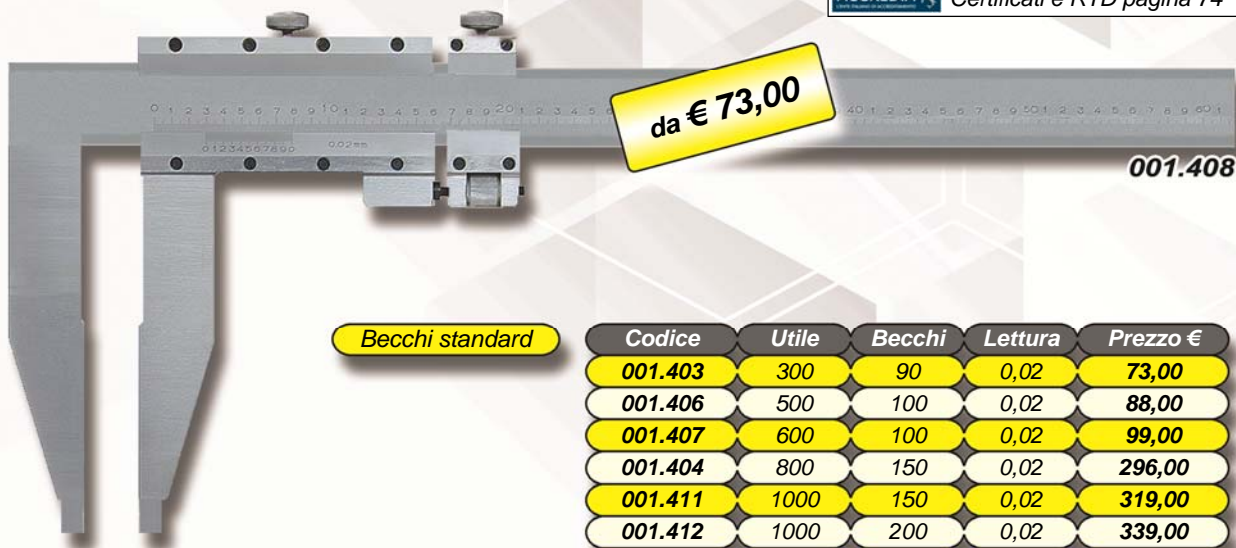

Becchi standard

Codice	Utile	Becchi	Lettura	Prezzo €
001.403	300	90	0,02	73,00
001.406	500	100	0,02	88,00
001.407	600	100	0,02	99,00
001.404	800	150	0,02	296,00
001.411	1000	150	0,02	319,00
001.412	1000	200	0,02	339,00
001.415	1500	200	0,02	629,00
001.420	2000	200	0,02	899,00

Becchi lunghi

Codice	Utile	Ponte	Lettura	Prezzo €
001.408	500	150	0,02	113,00
001.409	600	150	0,02	122,00
001.405N	600	300	0,02	190,00
001.413	1000	300	0,02	359,00
001.410N	1000	500	0,02	636,00
001.421	2000	300	0,02	948,00
001.425	2500	300	0,02	1543,00
001.430	3000	300	0,02	1923,00



Imballo in astuccio di legno non contestabile in caso di rottura durante il trasporto

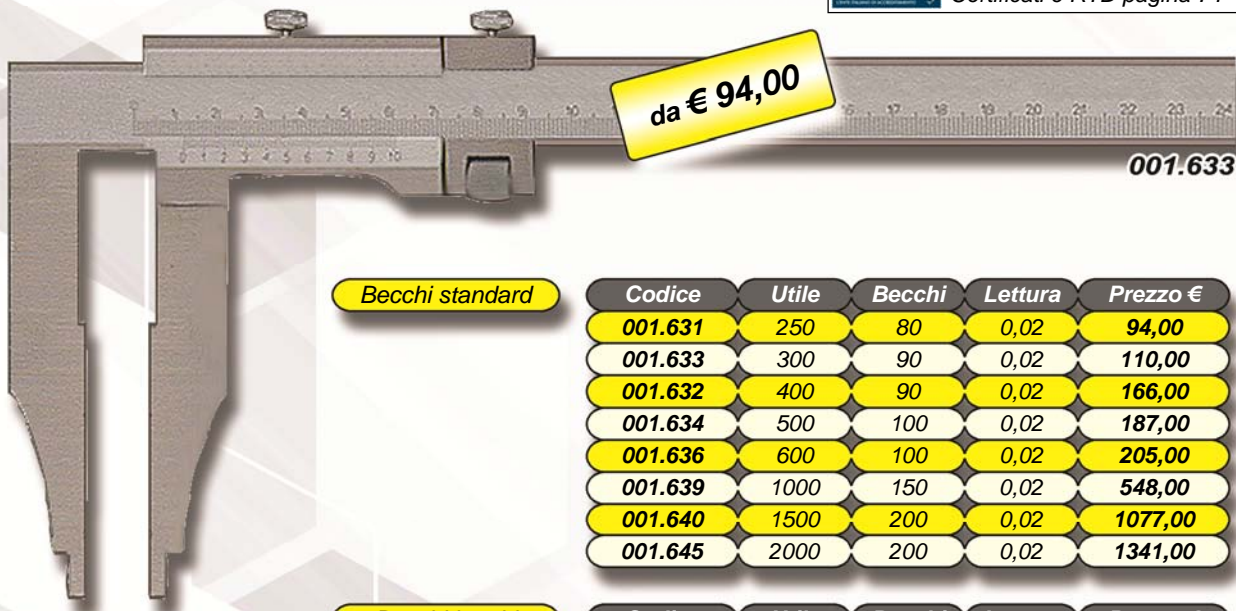

Becchi standard

Codice	Utile	Becchi	Lettura	Prezzo €
001.631	250	80	0,02	94,00
001.633	300	90	0,02	110,00
001.632	400	90	0,02	166,00
001.634	500	100	0,02	187,00
001.636	600	100	0,02	205,00
001.639	1000	150	0,02	548,00
001.640	1500	200	0,02	1077,00
001.645	2000	200	0,02	1341,00

Becchi lunghi

Codice	Utile	Becchi	Lettura	Prezzo €
001.762	300	150	0,02	163,00
001.635	500	150	0,02	228,00
001.769	500	250	0,02	395,00
001.637	600	150	0,02	281,00
001.774	600	300	0,02	567,00
001.775	1000	300	0,02	793,00
001.776	1000	500	0,02	1460,00
001.646	2000	300	0,02	1846,00
001.647	3000	300	0,02	2878,00



Imballo in astuccio di legno non contestabile in caso di rottura durante il trasporto





Becchi standard

Codice	Utile	Becchi	Lettura	Prezzo €
001.973	300	100	0,01	174,50
001.974	500	100	0,01	208,00
001.976	600	100	0,01	340,00
001.978	800	150	0,01	441,00
001.980	1000	150	0,01	624,00

Becchi lunghi

Codice	Utile	Becchi	Lettura	Prezzo €
001.972	300	150	0,01	219,00
001.975	500	150	0,01	257,00
001.975L	500	200	0,01	310,00
001.977	600	150	0,01	373,00
001.977L	600	200	0,01	414,00
001.979	600	300	0,01	549,00
001.980L	1000	300	0,01	1109,00
001.981	1500	200	0,01	1372,00
001.982	2000	200	0,01	1760,00
001.982L	2000	300	0,01	1800,00



Codice	Utile	Becchi	Lettura	Prezzo €
009.005	500	100	0,01	263,00
009.006	800	150	0,01	480,00
009.007	1000	150	0,01	581,00



Tenere lontano da magneti o campi magnetici forti!!!

Codice	Utile	Becchi	Lettura	Prezzo €
001.943	500	100	0,01	325,00
001.944	500	150	0,01	408,00
001.945	500	200	0,01	431,50
001.942	600	100	0,01	452,00
001.946	600	150	0,01	469,00
001.947	600	200	0,01	627,00
001.948	1000	150	0,01	745,00
001.949	1000	200	0,01	948,00

ACCREDIA Certificati e RDT pagina 74



da € 409,00

224.113

Codice	Utile	Becchi	Lettura	Prezzo €
224.113	300	100	0,01	409,00
224.114	400	100	0,01	464,00
224.115	500	100	0,01	509,00
224.115A	600	100	0,01	565,00
224.116	600	150	0,01	1019,00
224.120	1000	150	0,01	1599,00



ACCREDIA Certificati e RDT pagina 74



da € 1334,00

225.100

Codice	Utile	Becchi	Lettura	Prezzo €
225.100	1000	150	0,01	1334,00
225.150	1500	150	0,01	1763,00
225.200	2000	150	0,01	2398,00



ACCREDIA Certificati e RDT pagina 74

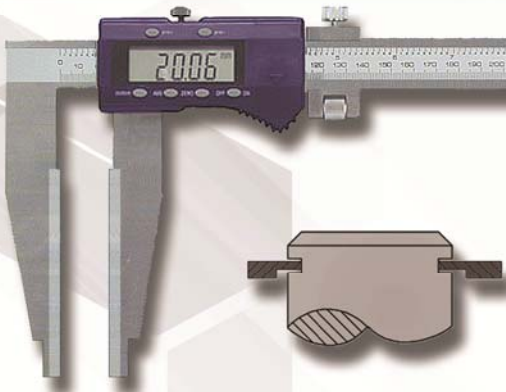

da € 303,00

001.963

Codice	Utile	Becchi	Lettura	Prezzo €
001.963	300	90	0,01	303,00
001.965	500	150	0,01	395,00



ACCREDIA Certificati e RDT pagina 74



da € 386,00

001.953

Elettronica "Preset" per una lettura diretta

Codice	Utile	Becchi	Lettura	Prezzo €
001.953	300	90	0,01	386,00
001.955	500	150	0,01	492,00

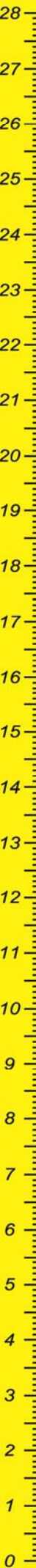



Codice	Utile	Ponte	Lettura	Prezzo €
001.502	200	100	0,02	36,00
001.503	300	100	0,02	46,00
001.504	300	150	0,02	70,00

**Novità**

Calibri di profondità digitali - Bloccaggio a vite superiore - Elettronica con funzione Hold



Codice	Utile	Ponte	Lettura	Prezzo €
001.912	150	100	0,01	57,00
001.914	200	100	0,01	66,00
001.913	300	100	0,01	90,00
001.917	200	150	0,01	76,00
001.916	300	150	0,01	110,00
001.915	500	150	0,01	159,00



Codice	Utile	Ponte	Lettura	Prezzo €
001.931	150	100	0,01	73,00
001.934	200	100	0,01	89,00
001.933	300	100	0,01	124,00
001.937	200	150	0,01	101,00
001.936	300	150	0,01	146,00



Codice	Utile	Ponte	Lettura	Prezzo €
001.922	200	100	0,01	81,00
001.923	300	150	0,01	110,00
001.925	500	150	0,01	211,00



Codice	Utile	Ponte	Lettura	Prezzo €
001.926	200	100	0,01	103,00
001.927	300	100	0,01	112,00
001.928	500	100	0,01	209,00



ACCREDIA Certificati e RTD pagina 74

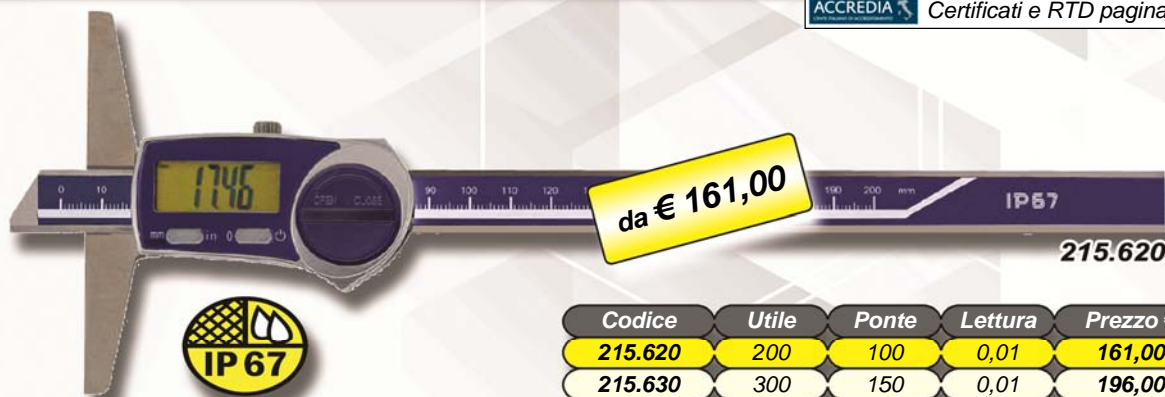

Codice	Utile	Ponte	Lettura	Prezzo €
215.620	200	100	0,01	161,00
215.630	300	150	0,01	196,00

ACCREDIA Certificati e RTD pagina 74



Codice	Utile	Ponte	Lettura	Prezzo €
009.303	300	100	0,01	113,00
009.312	200	150	0,01	79,00
009.313	300	150	0,01	118,00
009.315	500	150	0,01	199,00

009.333

Con punta Ø 1,5 x L4,5mm

Codice	Utile	Ponte	Lettura	Prezzo €
009.333	300	150	0,01	128,00

009.342

Con gancio per gole Ø min 28mm

Codice	Utile	Ponte	Lettura	Prezzo €
009.342	200	100	0,01	103,00
009.353	300	150	0,01	150,00
009.355	500	150	0,01	266,00

ACCREDIA Certificati e RTD pagina 74



Codice	Utile	Becchi	Lettura	Prezzo €
001.562	150	100	0,02	21,00
001.563	200	100	0,02	27,00



Fuori catalogo

Mini-micrometri centesimali - Arco e tamburo cromati - Senza frizione

ACCREDIA Certificati e RTD pagina 74



€ 19,00

002.000

Codice	Utile	Vite Ø	Passo	Prezzo €
002.000	0:15	5	0,5	19,00

Catalogo 2/4

Micrometri centesimali - Modello standard - Arco tondo verniciato

ACCREDIA Certificati e RTD pagina 74



da € 25,00

002.891

Misure oltre 0-25 con arco alleggerito  
Frizione a cricchetto  
Passo 0,5mm (2 giri 1mm) - Tamburo cromato 18mm  
Vite Ø 6,5mm contatti in metallo duro



da € 28,00

002.892

Codice	Utile	Risc.	Arco	Prezzo €
002.891	0:25	---	28	25,00
002.892	25:50	25	38	28,00
002.893	50:75	50	49	30,00
002.894	75:100	75	60	32,00

002.895	100:125	100	73	37,00
002.896	125:150	125	85	42,00
002.897	150:175	150	104	50,00
002.898	175:200	175	117	55,00

002.899	200:225	200	130	63,00
002.900	225:250	225	142	68,00
002.901	250:275	250	152	75,00
002.902	275:300	275	167	80,00

Assortimenti

Codice	Utile	Assortimenti	Prezzo €
002.903	0:100	4 micrometri	99,00
002.904	0:150	6 micrometri	173,00
002.907	0:300	12 micrometri	511,00

002.905	100:200	4 micrometri	188,00
002.908	200:300	4 micrometri	293,00



da € 99,00

002.904

Micrometri centesimali - Modello standard - Arco quadro verniciato

Catalogo 2/5

ACCREDIA Certificati e RDT pagina 74



002.071

da € 25,00

Codice	Utile	Risc.	Arco	Prezzo €
002.071	0:25	---	24	25,00
002.072	25:50	25	32	28,00
002.073	50:75	50	45	30,00
002.074	75:100	75	57	32,00
002.075	100:125	100	70	37,00
002.076	125:150	125	82	43,00
002.077	150:175	150	95	51,00
002.080	175:200	175	107	56,00

Set micrometri centesimali - Modello standard - Arco quadro verniciato

Catalogo 2/5

ACCREDIA Certificati e RDT pagina 74



002.078

da € 99,00

Codice	Utile	Assortimenti	Prezzo €
002.078	0:100	4 micrometri	99,00
002.079	0:150	6 micrometri	173,00

Micrometri centesimali - Tamburo Ø 30mm - Arco quadro verniciato - Passo 1mm

Catalogo 2/5

ACCREDIA Certificati e RDT pagina 74



002.251

da € 58,00

Codice	Utile	Risc.	Arco	Prezzo €
002.251	0:25	---	24	58,00
002.252	25:50	25	32	63,00
002.253	50:75	50	45	69,00
002.254	75:100	75	57	84,50
002.255	100:125	100	70	96,50
002.256	125:150	125	82	109,00
002.257	150:175	150	95	121,00
002.258	175:200	175	107	135,00

Micrometri millesimali - Lettura esente da parallasse - Tamburo Ø 19,5mm

Catalogo 2/8

ACCREDIA Certificati e RDT pagina 74



002.501

da € 61,00

Letture 0,001mm

Codice	Utile	Risc.	Arco	Prezzo €
002.501	0:25	---	24	61,00
002.502	25:50	25	32	66,00
002.503	50:75	50	45	71,00
002.504	75:100	75	57	88,00

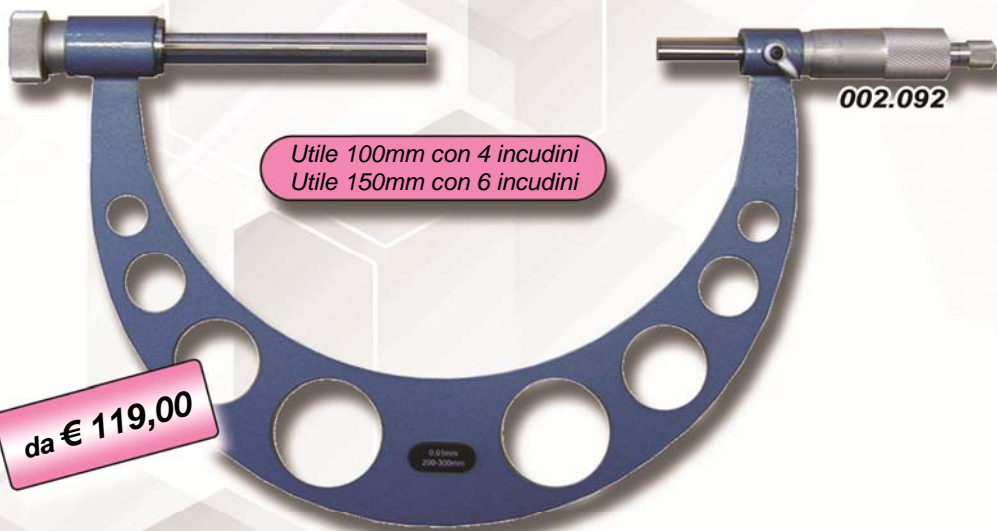

Utile 100mm con 4 incudini  
Utile 150mm con 6 incudini

da € 119,00

Disponibili anche in versione con comparatore 0,01mm oppure digitale 0,001mm

Codice	Utile	Riscontri	Prezzo €
002.091	0:100	3/25-75	119,00
002.092	100:200	4/100-175	170,00
002.093	200:300	4/200-275	198,00
002.081	0:150	5/25-125	188,00
002.082	150:300	5/150-275	227,00



Imballo in astuccio di legno non contestabile in caso di rottura durante il trasporto

da € 259,00

002.028

Fino 1000mm corsa 25mm passo 0,5mm  
1 incudine 100mm e 2 distanziatori 25 e 50



Oltre 1000mm corsa 50mm passo 1mm  
1 incudine 200mm e 2 distanziatori 50 e 100



Codice	Utile	Corsa	Tamb	Passo	Prezzo €	Codice	Utile	Corsa	Tamb	Passo	Prezzo €
002.021	300:400	25	18	0,5	259,00	002.028	1000:1200	50	30	1	1089,00
002.022	400:500	25	18	0,5	289,00	002.029	1200:1400	50	30	1	1249,00
002.023	500:600	25	18	0,5	349,00	002.030	1400:1600	50	30	1	1410,00
002.024	600:700	25	18	0,5	399,00	002.031	1600:1800	50	30	1	1550,00
002.025	700:800	25	18	0,5	479,00	002.032	1800:2000	50	30	1	1650,00
002.026	800:900	25	18	0,5	580,00						
002.027	900:1000	25	18	0,5	647,00						

Fino a 3000 sempre in pronta consegna



Imballo in astuccio di legno non contestabile in caso di rottura durante il trasporto

da € 461,00

Codice	Utile	Tamb	Passo	Prezzo €	Codice	Utile	Tamb	Passo	Prezzo €
002.521	300:400	18	0,5	461,00	002.524	600:700	18	0,5	619,00
002.522	400:500	18	0,5	541,00	002.525	700:800	18	0,5	709,00
002.523	500:600	18	0,5	606,00	002.526	800:900	18	0,5	932,00
					002.527	900:1000	18	0,5	1062,00

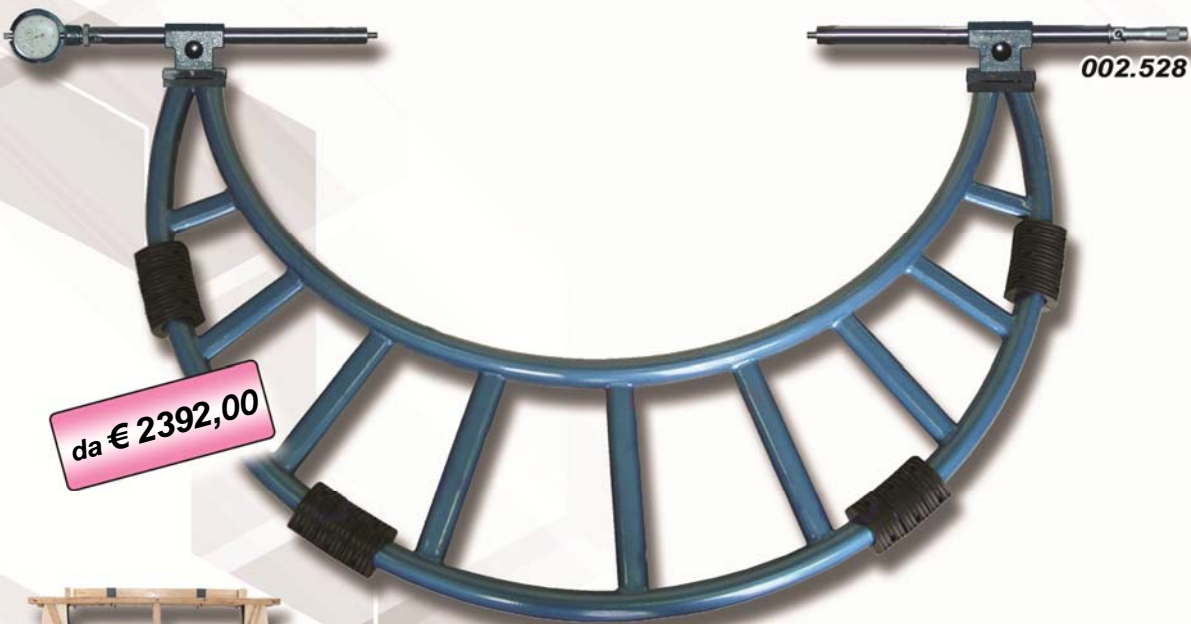

da € 2392,00



Codice 002.530 e 002.531 misura oltre 2000mm diventa trasporto eccezionale  
**Chiedere spesa di trasporto**

Codice	Utile	Tamb	Passo	Prezzo €
002.528	1000:1500	18	0,5	2392,00
002.529	1500:2000	18	0,5	2631,00
002.530	2000:2500	18	0,5	3272,00
002.531	2500:3000	18	0,5	3486,00

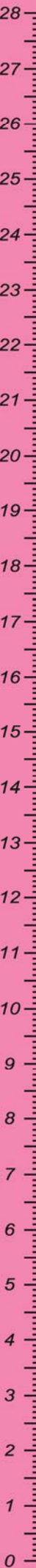

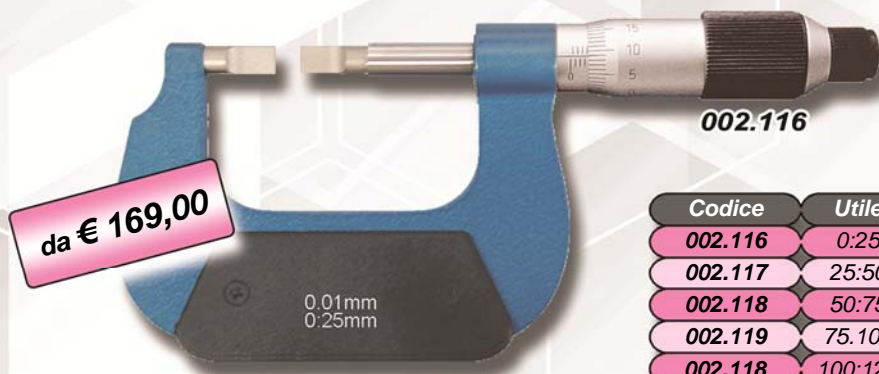

002.116

Codice	Utile	Contatti	Arco	Prezzo €
002.116	0:25	0,75x6,5	37	169,00
002.117	25:50	0,75x6,5	50	172,00
002.118	50:75	0,75x6,5	62	182,00
002.119	75:100	0,75x6,5	70	221,00
002.118	100:125	0,75x6,5	82	235,00
002.119	125:150	0,75x6,5	95	252,00

Contatti ridotti

002.116A	0:25	0,4x3,5	37	169,00
----------	------	---------	----	--------

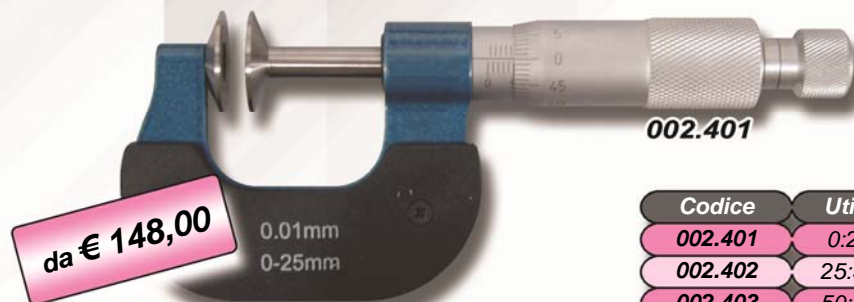

002.401

Codice	Utile	Piatt.	Arco	Prezzo €
002.401	0:25	Ø 20	24	148,00
002.402	25:50	Ø 20	32	165,00
002.403	50:75	Ø 20	45	177,00
002.404	75:100	Ø 20	57	198,00

Vite Ø 8mm passo 0,5mm  
Senza bloccaggio  
Disponibili fino a 200mm piattelli Ø 30mm

002.401A	0:25	Ø 30	24	188,50
002.402A	25:50	Ø 30	32	208,00
002.403A	50:75	Ø 30	45	212,00
002.404A	75:100	Ø 30	57	233,00
002.405	100:125	Ø 30	70	241,00



009.261

Codice	Utile	Piatt.	Arco	Prezzo €
009.261	0:25	Ø 20	26	189,00
009.262	25:50	Ø 20	38	210,00
009.263	50:75	Ø 20	50	217,00
009.264	75:100	Ø 20	62	229,00

Vite Ø8mm passo 0,5mm  
Disponibili fino a 200mm piattelli Ø 30mm

009.261A	0:25	Ø 30	26	234,00
009.262A	25:50	Ø 30	38	260,00
009.263A	50:75	Ø 30	50	270,00
009.264A	75:100	Ø 30	62	286,00
009.265	100:125	Ø 30	70	295,00
009.266	125:150	Ø 30	82	328,50

ACCREDIA Certificati e RTD a richiesta

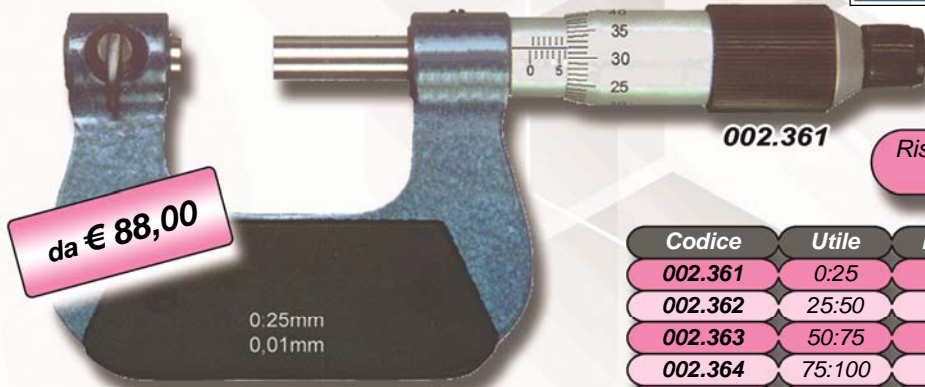

002.361

Riscontri e capruggini Ø 5x15mm  
Non compresi

Codice	Utile	Risc.	Arco	Prezzo €
002.361	0:25	---	26	88,00
002.362	25:50	---	38	100,00
002.363	50:75	---	50	112,00
002.364	75:100	---	62	126,00
002.365	100:125	---	70	153,00
002.366	125:150	---	82	159,00
002.367	150:175	---	92	190,00
002.368	175:200	---	107	209,00

Capruggini 55°

Codice	Passo Ww	Filetto	Prezzo €
002.399A	60-48	55°	19,00
002.399B	48-40	55°	19,00
002.399C	40-32	55°	19,00
002.399D	32-24	55°	19,00
002.399E	24-18	55°	19,00
002.399F	18-14	55°	19,00
002.399G	14-10	55°	19,00
002.399H	10-7	55°	19,00
002.399I	7-4,5	55°	19,00
002.399K	4,5-3,5	55°	19,00
002.399	10 coppie passo Ww 60-3,5		178,00

Capruggini 60°

Codice	Passo M	Filetto	Prezzo €
002.398A	0,4-0,5	60°	20,00
002.398B	0,6-0,9	60°	20,00
002.398C	1,0-1,75	60°	20,00
002.398D	2,0-3,0	60°	20,00
002.398E	3,5-5,0	60°	20,00
002.398F	5,5-7,0	60°	20,00
002.398	6 coppie passo M 0,4-7,0		97,00

Riscontri 55°

Codice	Lunghezza	Gradi	Prezzo €
002.390	25	55°	33,00
002.391	50	55°	37,00
002.392	75	55°	41,00
002.393	100	55°	49,00
002.394	125	55°	56,00
002.395	150	55°	66,00
002.396	175	55°	73,00

Riscontri 60°

Codice	Lunghezza	Gradi	Prezzo €
002.380	25	60°	33,00
002.381	50	60°	37,00
002.382	75	60°	41,00
002.383	100	60°	49,00
002.384	125	60°	56,00
002.385	150	60°	66,00
002.386	175	60°	73,00

**Terne di fili calibrati per la misurazione di filetti** Fuori catalogo



800.809

€ 140,00 cad

Codice	Codice	Ø filo	Filetto M	Passo	Filetto Ww	Unc/Unf	Trapez
Ø 6,5	Ø 8	d	nominal	60°	55°	60°	30°
800.801	800.801A	0,170	M 1-1,2-1,4	0,25-0,30	---	---	---
800.802	800.802A	0,220	M 1,6-1,8	0,35	---	72	---
800.803	800.803A	0,250	M 2	0,40	60	64	---
800.804	800.804A	0,290	M 2-2,5-3	0,45-0,50	---	56	---
800.805	800.805A	0,335	M 3,5	0,60	48-40	48-44	---
800.806	800.806A	0,455	M 4-4,5-5	0,70-0,75-0,80	---	---	---
800.800	800.800A	0,530	M 5,5	0,90	32-28	32-28	---
800.807	800.807A	0,620	M 6-7	1,00	26-24	24	---
800.808	800.808A	0,725	M 8-9	1,25	22-20-19	20	---
800.809	800.809A	0,895	M 10-11	1,50	18-16	18-16	---
800.810	800.810A	1,100	M 12	1,75	14	14-13	2
800.811	800.811A	1,350	M 14-16	2,00	12-11	12-11	---
800.812	800.812A	1,650	M 18-20-22	2,50	10-9	10-9	3
800.813	800.813A	2,050	M 24-27-30-33	3,00-3,50	8-7	8-7	4
800.814	800.814A	2,550	M 36-39-42-45	4,00-4,50	6	6	5
800.815	800.815A	3,200	M 48-52-56-60	5,00-5,50	5-4½	5-4½	6

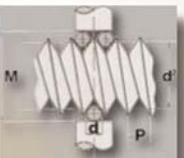



da € 60,00

Codice	Utile	Anello	Prezzo €
002.141	5:30	Ø 5	60,00
002.142	25:50	Ø 25	67,50
002.143	50:75	---	85,00
002.144	75:100	---	96,50
002.155	100:125	---	113,00
002.156	125:150	---	125,00



da € 305,00



002.149A

Codice	Utile	Anelli e Risc.	Prezzo €
002.149	5:100	Ø 5+25	305,00
002.149A	5:100	Ø 5+25+75	353,00



da € 183,00

Codice	Utile	Aste	Prezzo €
002.135	50:600	Ø 15,5	183,00

Aste di ricambio

Codice	Lunghezza	Sezione	Prezzo €
002.130D	100	Ø 15,5	48,50
002.130F	200	Ø 15,5	55,00
002.130G	300	Ø 15,5	86,50



da € 387,00

Vite micrometrica passo 0,5 corsa 15mm  
Forniti in cofanetti di alluminio  
Aste da 13 a 300mm

Codice	Passo M	Aste	Prezzo €
002.138	50:1000	Ø 15,5	387,00
002.138G	50:1500	Ø 15,5	576,00



Micrometri centesimali per fili - Acciaio cromato - Vite Ø6,5mm rotante passo 0,5mm

Catalogo 2/48

ACCREDIA Certificati e RTD pagina 74



Codice	Utile	Lettura	Prezzo €
002.161	0:10	0,01	63,50
002.162	0:13	0,01	61,30

Micrometri centesimali di profondità - Aste intercambiabili - Bloccaggio a vite - Passo 0,5mm

Catalogo 2/74

ACCREDIA Certificati e RTD pagina 75

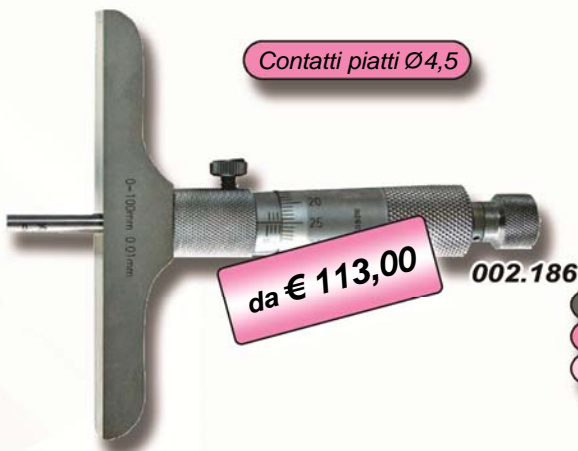

Codice	Utile	Lettura	Prezzo €
002.186	0:100	0,01	113,00
002.187	0:200	0,01	168,00

Testine micrometriche centesimali e millesimali - Corsa 25mm - Codolo Ø12mm

Cat. 2/76-77

ACCREDIA Certificati e RTD pagina 75



002.275 Tamburo senza parallasse

Codice	Utile	Lettura	Prezzo €
002.241	0:25	0,01	23,50
002.271	0:25	0,01	36,50
002.272	0:25	0,002	38,50
002.275	0:25	0,001	38,50

Portamicrometri inclinabili - 002.201 acciaio - 002.203 fusione leggera

Catalogo 2/81



Codice	Micrometri	Apertura	Prezzo €
002.201	<300	14	38,50
002.203	<200	21	18,00



Disponibili a richiesta  
fino a 300mm

da € 190,00

002.309P

002.313P

Codice	Utile	Anello	Prezzo €
002.301P	6:8	Ø 8	260,00
002.302P	8:10	Ø 8	260,00
002.303P	10:12	Ø 10	260,00
002.304P	12:16	Ø 12	190,00
002.305P	16:20	Ø 16	190,00
002.306P	20:25	Ø 20	240,00
002.307P	25:30	Ø 25	240,00
002.308P	30:40	Ø 30	280,00
002.309P	40:50	Ø 40	320,00
002.310P	50:63	Ø 50	320,00
002.311P	63:75	Ø 62	350,00
002.312P	75:88	Ø 87	360,00
002.313P	87:100	Ø 87	380,00
002.314P	100:125	---	492,00
002.315P	125:150	---	492,00

Assortimenti  
inclusi anelli e prolunghe

Codice	Utile	Anelli	Prezzo €
002.325P	6:12	Ø 8+10	661,00
002.326P	12:20	Ø 16	333,00
002.327P	20:50	Ø 25+40	880,00
002.328P	50:100	Ø 62+87	1170,00



Bowers



Analogici serie 889

Digitali serie 987

Pistola serie 988

Utile	Analogico	Digitale	Pistola
Inizio cod.	889	987	988
Contatti temprati - Incluso anello			
6:8	889.516	987.716	988.716
8:10	889.517	987.717	988.717
10:12,5	889.518	987.718	988.718
Contatti in metallo duro - Incluso anello - Fondo gola			
12,5:16	889.519	987.719	988.719
16:20	889.520	987.720	988.720
20:25	889.521	987.721	988.721
25:35	889.522	987.722	988.722
35:50	889.523	987.723	988.723
50:65	889.524	987.724	988.724
65:80	889.525	987.725	988.725
80:100	889.526	987.726	988.726
100:125	889.527	987.727	988.727
125:150	889.528	987.728	988.728
150:175	889.529	987.729	988.729
175:200	889.530	987.730	988.730
Assortimenti - Incluso anello/i			
6:10	889.553	987.753	988.753
10:20	889.554	987.754	988.754
20:50	889.555	987.755	988.755
50:100	889.556	987.756	988.756
100:150	889.557	987.757	988.757
150:200	889.558	987.758	988.758
6:20	---	---	988.751
20:100	---	---	988.752
100:200	---	987.759	988.759

ACCREDIA Certificati e RTD pagina 74



009.521

Codice	Utile	Risc.	Lettura	Prezzo €
009.521	0:25	---	0,001	105,00
009.522	25:50	25	0,001	121,00
009.523	50:75	50	0,001	160,00
009.524	75:100	75	0,001	189,00
009.525	100:125	100	0,001	205,00
009.526	125:150	125	0,001	217,00
009.527	150:175	150	0,001	240,00
009.528	175:200	175	0,001	256,00
009.529	200:225	200	0,001	281,00
009.530	225:250	225	0,001	299,00
009.530A	250:275	250	0,001	319,00
009.530B	275:300	275	0,001	333,00

Corsa 1 giro 2 mm  
Frizione e cricchetto in PVC



009.541

Codice	Utile	Risc.	Lettura	Prezzo €
009.541	0:25	---	0,001	130,00
009.542	25:50	25	0,001	160,00

ACCREDIA Certificati e RTD pagina 74



009.235

Codice	Utile	Risc.	Arco	Prezzo €
009.235	0:35	---	38	105,00
009.236	35:70	50	51	129,50
009.237	65:100	75	60	149,50

ACCREDIA Certificati e RTD pagina 74



009.561

Codice	Utile	Risc.	Arco	Prezzo €
009.562	25:50	25	32	112,50
009.563	50:75	50	47	136,50
009.564	75:100	75	61	168,50



Codice	Utile	Risc.	Arco	Prezzo €
009.211	0:25	---	26	98,00
009.212	25:50	25	32	113,00
009.213	50:75	50	44	136,50
009.214	75:100	75	57	158,00
009.215	100:125	100	70	185,00
009.216	125:150	125	82	210,00
009.217	150:175	150	94	232,00
009.218	175:200	175	107	255,00
009.219	200:225	200	129	271,00
009.220	225:250	225	142	293,00
009.221	250:275	250	155	316,00
009.222	275:300	275	167	327,00



Codice	Utile	Arco	Letture	Prezzo €
009.772	0:25(50)	37	0,001	218,00
009.774	50:75(100)	62	0,001	242,50
009.772	100:125(150)	82	0,001	302,00
009.774	150:175(200)	107	0,001	334,00
002.939	Set 7pz inserti vari			128,00
002.951A/J	1 coppia sfere disp. da Ø1 a Ø6			53,00



Codice	Utile	Risc.	Letture	Prezzo €
009.541	0:25	---	0,001	71,50
009.542	25:50	25	0,001	83,00

ACCREDIA Certificati e RTD a richiesta



da € 98,00

005.593



005.593



€ 74,50

005.598

Base piana in acciaio rettificato senza magneti

Codice	Lunghezza	Lettura	Prezzo €
005.599	150	0,05°	60,50

Base prismatica in acciaio con 12 magneti

Codice	Lunghezza	Lettura	Prezzo €
005.593	150	0,05°	98,00

Base semiprismatica in alluminio con 2 magneti

Codice	Lunghezza	Lettura	Prezzo €
005.598	150	0,05°	74,50

ACCREDIA Certificati e RTD a richiesta



da € 177,00

005.542

Codice	Utile	Precisione	Prezzo €
005.541	150x150	0,02	189,00
005.542	200x200	0,02	197,50
005.545	150x150	0,05	177,00
005.546	200x200	0,05	189,00

ACCREDIA Certificati e RTD a richiesta



da € 108,00

005.442

Codice	Utile	Precisione	Prezzo €
005.441	150	0,02	120,00
005.442	200	0,02	137,00
005.444	300	0,02	177,00
005.445	150	0,05	108,00
005.446	200	0,05	129,00



€ 82,00

003.068

Codice	Utile	Aste	Prezzo €
003.068	4x90°	150-200-300	82,00
003.075	Asta supplementare da 500		31,00



€ 68,50

003.066

Codice	Utile	Aste	Prezzo €
003.066	4x90°	150-200-300	68,50
003.075	Asta supplementare da 500		31,00



€ 317,50

003.995

Codice	Utile	Aste	Prezzo €
003.995	360°	150-200-300	317,50
003.994	Asta supplementare da 500		31,00



da € 11,50

003.351

003.352

Codice	Altezza	Base	Prezzo €
003.351	100	70	11,50
003.352	150	100	14,00
003.353	200	130	18,00
003.354	250	160	21,00
003.355	300	180	26,00
003.356	400	210	34,50
003.357	500	260	38,50

Goniometri semplici - Finitura cromata - Incisione a laser - Lettura 1°

Catalogo 3/14

ACCREDIA Certificati e RDT a richiesta



Codice	Arco Ø	Asta	Prezzo €
003.001N	80	120	12,50
003.002N	120	150	17,50
003.003N	150	200	22,00
003.004N	200	300	29,50
003.005N	250	500	56,00
003.006N	300	600	80,50

Disponibili fino a 400x1000mm

Goniometri con asta scorrevole - Finitura cromata - Incisione a laser - Lettura 1°

Catalogo 3/15

ACCREDIA Certificati e RDT a richiesta



Codice	Arco Ø	Asta	Prezzo €
003.011N	100	150	25,50
003.012N	150	300	31,50
003.013N	200	400	36,50
003.014N	250	500	53,00
003.015N	300	600	63,50

Goniometri semplici digitali - Lettura 0,05° - Utile 0-180°

Catalogo 3/17

ACCREDIA Certificati e RDT a richiesta



Codice	Base	Aste	Prezzo €
009.811	120	150	51,00
009.812	150	200	58,00
009.813	200	300	70,50
009.814	300	600	102,00

Disponibili fino a 400x1000mm

Squadre digitali - Lettura 0,05° - Aste graduate incise a laser - Utile 0-180°

Catalogo 3/17

ACCREDIA Certificati e RDT a richiesta



Codice	Base	Aste	Prezzo €
009.817	200	200	39,50
009.818	300	300	43,50



004.006

€ 24,50

Codice	Utile	Ghiera	Lettura	Prezzo €
004.006	0:5	Ø40	0,01	24,50



004.010

004.014

da € 14,00

Codice	Utile	Ghiera	Lettura	Prezzo €
004.010	0:10	Ø58	0,01	14,00

Codice	Utile	Ghiera	Lettura	Prezzo €
004.014	0:10	Ø58	0,01	21,00

Dispositivo antiurto con quadrante giallo



004.037

da € 71,00

Codice	Utile	Ghiera	Lettura	Prezzo €
004.037	0:30	Ø58	0,01	71,00
004.039	0:50	Ø58	0,01	99,50
004.038	0:80	Ø58	0,01	180,00



004.041

da € 22,00

Codice	Utile	Ghiera	Lettura	Prezzo €
004.041	0:10	Ø58	0,1	22,00
004.043	0:30	Ø58	0,1	47,50



Compartatori centesimali - Ghiera Ø40 o 58 mm - Lancette concentriche - Cassa metallica

Catalogo 4A/7

ACCREDIA Certificati e RDT pagina 78



702.045

da € 27,00

702.058

Codice	Utile	Ghiera	Lettura	Prezzo €
702.045	0:10	Ø40	0,01	28,00
702.058	0:10	Ø58	0,01	27,00

Comparatori originali Käfer centesimali - Serie speciali promozionali

Catalogo 4A/10

ACCREDIA Certificati e RDT pagina 78



701.200

da € 38,50

701.100



Codice	Utile	Ghiera	Lettura	Prezzo €
701.200	0:10	Ø58	0,01	38,50

Codice	Utile	Ghiera	Lettura	Prezzo €
701.100	0:10	Ø58	0,01	53,50

Ghiera metallica, cappuccio antipolvere e puntalino in rubino

Compartatori centesimali - Antispruzzo con ghiera avvitata - Soffietto copristelo

Catalogo 4A/12

ACCREDIA Certificati e RDT pagina 78



004.708

€ 52,00



Antispruzzo

Codice	Utile	Ghiera	Lettura	Prezzo €
004.708	0:10	Ø61,5	0,01	52,00

Comparatori millesimali - Quadrante giallo 1 giro = 0,1mm

Catalogo 4A/16

ACCREDIA Certificati e RDT pagina 78



004.051

€ 63,00

Codice	Utile	Ghiera	Lettura	Prezzo €
004.051	0:1	Ø58	0,001	63,00

Novità

Compartatori digitali centesimali - 0,01 mm/inch

ACCREDIA Certificati e RTD pagina 78



004.945

mm/inch

Codice	Utile	Letture	Precis.	Prezzo €
004.945	0:12	0,01	16 µm	47,00

Catalogo 4A/20

Comparatori digitali 0,01 o 0,001 - Funzioni ABS-Inc-Tol (\*) oppure Preset ± (\*\*)

ACCREDIA Certificati e RTD pagina 78



ABS-Inc-Tol

Preset ±

004.948

004.980

Codice	Utile	Letture	Precis.	Prezzo €
004.948*	0:12	0,01	10 µm	75,00
004.949*	0:25	0,01	15 µm	110,00
004.950*	0:50	0,01	20 µm	165,00
004.975*	0:12	0,001	7,5 µm	88,50
004.981*	0:12	0,001	4,5 µm	96,00
004.986*	0:12	0,001	2,5 µm	138,00

Codice	Utile	Letture	Precis.	Prezzo €
004.968**	0:12	0,01	10 µm	76,00
004.980**	0:12	0,001	4,5 µm	96,00
004.985**	0:12	0,001	2,5 µm	138,00

Catalogo 4A/21

Compartatori digitali centesimali o millesimali - Uscita compatibile con altri sistemi

ACCREDIA Certificati e RTD pagina 78



004.959

Tol-Org-ABS-Preset



RB 6

Uscita dati

Codice	Utile	Letture	Precis.	Prezzo €
004.951	0:12	0,01	10 µm	99,50
004.952	0:25	0,01	15 µm	133,00
004.953	0:50	0,01	20 µm	207,00

Codice	Utile	Letture	Precis.	Prezzo €
004.959	0:12	0,001	2 µm	142,00

Catalogo 4B/23

Alesametri semplici - Finitura cromata - Comparatore 1/100° compreso - (004.556 set digitale)

ACCREDIA Certificati e RTD a richiesta

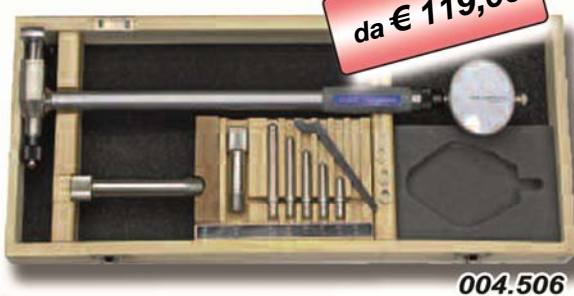

004.506

Set alesametri con comparatore digitale

Codice	Utile	Profondità	Prezzo €
004.501	6:10	45	119,00
004.502	10:18	100	119,00
004.503	18:35	150	119,00
004.504	35:50	150	119,00
004.514	35:70	150	135,00
004.506	50:160	150	123,00
004.526	50:160	500	195,00
004.507	160:250	400	127,50
004.508	250:450	400	146,50
Set 004.555	18:160	150	315,50
Set 004.556	18:160	150	410,00

ACCREDIA Certificati e RTD a richiesta



da € 212,00

520.105L



Codice	Utile	Profondità	Prezzo €
520.101	15:35	175	212,00
520.102	30:100	250	212,00
520.103	50:160	250	250,50
520.104	50:210	380	273,50
520.104L	50:265	380	291,00
520.105	100:300	350	382,50
520.105L	100:500	350	512,00
520.106	100:500	650	626,50
520.107	190:1000	650	1134,00

Alesametri TOP - Contatti in metallo duro - (530.211/8) asta corta - Comparatori esclusi

Novità

ACCREDIA Certificati e RTD a richiesta



da € 305,50

530.202



Codice	Utile	Profondità	Prezzo €
530.211	15:35	35	362,00
530.212	30:100	130	368,50
530.213	30:160	130	395,50
530.215	100:300	220	648,50
530.216	100:500	350	832,50
530.217	190:1000	440	1614,50
530.218	220:1000	440	1662,50
530.201	15:35	175	305,50
530.202	30:100	250	305,50
530.203	50:160	250	324,50
530.204	50:210	380	385,00
530.205	100:300	350	585,50
530.206	100:500	650	832,50
530.207	190:1000	650	1468,00
530.208	220:1000	650	1510,00

\*Asta corta consegna 3/4 settimane

Alesametri Schwenk - Serie Rabito - Contatti in acciaio temprato - Comparatori esclusi

Catalogo 4B/24

ACCREDIA Certificati e RTD a richiesta



da € 255,50

531.603



Codice	Utile	Profondità	Prezzo €
531.601	18:35	110	263,50
531.602	35:60	138	255,50
531.603	50:150	177	297,00
531.604	150:300	177	529,00

Errore massimo 3 micron

Set 531.610 18:150 Vedere sopra 515,50

Catalogo 4B/4

Misuratori rapidi centesimali - Analogici per interni Kroeplin - Serie H - Sfera Ø1 - IP65

ACCREDIA Certificati e RDT a richiesta



**Kroeplin**  
Längenmesstechnik



richiesta

440.912

Codice	Utile	Tipo	Bracci	Prezzo €
440.912	5:15	H 105	35	a richiesta
440.941	10:30	H 210	85	a richiesta
440.943	30:50	H 230	85	a richiesta
440.944	40:60	H 240	85	a richiesta
440.945	50:70	H 250	85	a richiesta

Catalogo 4B/6

Misuratori rapidi centesimali - Digitali per interni Kroeplin - Serie G - Sfera Ø1 - IP67

ACCREDIA Certificati e RDT a richiesta



**Kroeplin**  
Längenmesstechnik



richiesta

941.912

Codice	Utile	Tipo	Bracci	Prezzo €
941.911	2,5:12,5	G 102	12	a richiesta
941.912	5:15	G 105	35	a richiesta
941.941	10:30	G 210	85	a richiesta
941.942	20:40	G 220	85	a richiesta
941.943	30:50	G 230	85	a richiesta

Catalogo 4B/11

Misuratori rapidi centesimali - Digitali per esterni Kroeplin - Serie C - IP67

ACCREDIA Certificati e RDT a richiesta



**Kroeplin**  
Längenmesstechnik



richiesta

961.953

Codice	Utile	Tipo	Bracci	Prezzo €
961.953	0:20	C 220	85	a richiesta
961.957	0:50	C 450	167	a richiesta

Catalogo 4B/11

Misuratori rapidi decimali - Analogici per esterni Kroeplin - Serie Pocotest

ACCREDIA Certificati e RDT a richiesta

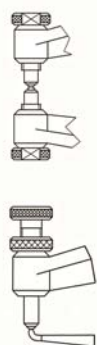

445.631



445.633

richiesta

**Kroeplin**  
Längenmesstechnik

Codice	Utile	Tipo	Bracci	Prezzo €
445.631	0:10	Poco 2K	36	a richiesta
445.633	0:10	Poco 2R	33,5	a richiesta

Tastatori centesimali - Forma A- Puntalini standard o lunghi

Catalogo 4A/27

ACCREDIA Certificati e RTD pagina 78



Codice	Utile	Quadr.	Puntale	Prezzo €
004.104	0:0,8	Ø38	L 16	51,50
004.105	0:0,8	Ø32	L 16	51,50

Codice	Utile	Quadr.	Puntale	Prezzo €
004.118	0:0,8	Ø38	L 30	87,00
004.119	0:0,8	Ø32	L 30	87,00

Tastatori centesim.- Tipo C (004.111) - Tastatori bi-millesim. - Tipo A (004.209)

Cat. 4A/27-29

ACCREDIA Certificati e RTD pagina 78



Codice	Utile	Quadr.	Puntale	Prezzo €
004.111	0:0,8	Ø32	L 12	58,00

Codice	Utile	Quadr.	Puntale	Prezzo €
004.209	0:0,2	Ø32	L 14	71,00

Tastatori centesimali originali Käfer - Forma A - Puntalini standard o lunghi

Catalogo 4A/27

ACCREDIA Certificati e RTD pagina 78



Codice	Utile	Quadr.	Puntale	Prezzo €
714.101	0:0,8	Ø32	L 12,8	110,00
714.102	0:0,8	Ø40	L 12,8	113,00

Codice	Utile	Quadr.	Puntale	Prezzo €
714.107	0:0,5	Ø32	L 35,7	155,00
714.108	0:0,5	Ø40	L 35,7	158,50

Tastatori bi-millesimali Käfer - Forma A - Accessori per tastatori

Catalogo 4A/27

ACCREDIA Certificati e RTD pagina 78



Codice	Utile	Quadr.	Puntale	Prezzo €
714.201	0:0,2	Ø32	L 12,8	133,50
714.202	0:0,2	Ø40	L 12,8	137,00

714.998	Archetto Ø8 - fori Ø4 e Ø8mm	19,00
---------	------------------------------	-------

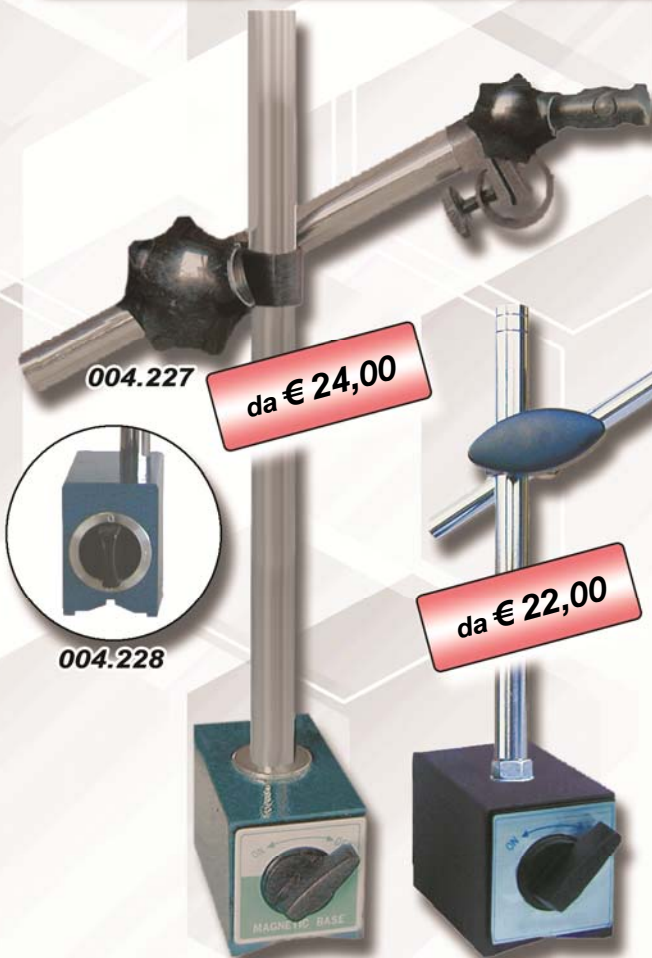

Codice	Montante	Traversa	Kg/Fil	Prezzo €
004.261	Ø12/175	Ø10/150	60/M8	22,00
004.377	Ø16/230	Ø14/200	100/M8	36,00

Senza vite micrometrica



Codice	Montante	Traversa	Kg/Fil	Prezzo €
004.263	Ø12/175	Ø10/150	60/M8	24,00
004.276	Ø16/230	Ø14/200	100/M8	39,00

Con vite micrometrica

Codice	Montante	Traversa	Kg/Fil	Prezzo €
004.226	Ø16/210	Ø16/210	60/M10	56,50
004.227	Ø20/350	Ø16/350	120/M12	92,50
004.228	Ø20/420	Ø16/390	80/M12	99,50

Con vite micrometrica



Codice	H totale	Magnete	Prezzo €
004.286	375	80kg M8	119,50
004.288	455	100kg M8	173,00
004.288C4	Comparatore Ø58 - Tastatore Ø40 Archetto Ø4+Ø8 - Prolunga 200		255,00

004.288 confezione cofanetto in alluminio

Codice	H totale	Magnete	Prezzo €
004.215	340	60kg M8	53,00
004.216	340	60kg M8	66,00

004.216 con magnete lamellare da 60kg



Magnete VOGEL

004.305



Magnete VOGEL

004.295

Tastatore non compreso

Codice	Raggio	Magnete	Prezzo €
004.295	200	80kg M8	169,00
Equivalente codice catalogo 429.601			

Codice	Raggio	Magnete	Prezzo €
004.305	280	80kg M8	209,00
Equivalente codice catalogo 430.601			

Codice	Raggio	Magnete	Prezzo €
004.311	400	100kg M8	227,00
Equivalente codice catalogo 429.601			



Magnete VOGEL

004.256

Lo 004.256 possiede una precarica sotto il pomello centrale per irrigidire le aste



Magnete VOGEL

004.245

Tastatore non compreso

Codice	Raggio	Magnete	Prezzo €
004.245	200	80kg M8	193,00
Equivalente codice catalogo 424.601			

Codice	Raggio	Magnete	Prezzo €
004.256	280	100kg M8	264,00
Equivalente codice catalogo 420.602			





da € 124,00

510.047



Supplementi certificati di taratura D1

Codice	Prezzi	Comp	Gradi	Prezzo €
C005.032	32pz	A	0-1-2	216,00
C005.047	47pz	B-C	0-1-2	318,00
C005.087	87pz	D	0-1-2	594,00

Tabella composizione serie blocchetti di riscontro

Comp. A	Passo	N°
1,005	---	1
1,01 - 1,09	0,01	9
1,1 - 1,9	0,1	9
1 - 9	1	9
10 - 30	10	3
50	50	1

Comp. B	Passo	N°
1,005	---	1
1,01 - 1,19	0,01	19
1,2 - 1,9	0,1	8
1 - 9	1	9
10 - 100	10	10

Comp. C	Passo	N°
1,005	---	1
1,01 - 1,09	0,01	9
1,1 - 1,9	0,1	9
1 - 24	1	24
25 - 100	25	4

Comp. D	Passo	N°
1,001 - 1,009	0,001	9
1,01 - 1,49	0,01	49
0,5 - 9,5	0,5	19
10 - 100	10	10

Codice	Pezzi	Grado	Prezzo €
Composizione A			
510.032	32pz	0	327,50
511.032	32pz	1	224,00
512.032	32pz	2	124,00

Codice	Pezzi	Grado	Prezzo €
Composizione B			
510.047	47pz	0	469,00
511.047	47pz	1	328,00
512.047	47pz	2	173,00

Codice	Pezzi	Grado	Prezzo €
Composizione C			
511.048	47pz	1	331,50

Codice	Pezzi	Grado	Prezzo €
Composizione D			
510.087	87pz	0	669,00
511.087	87pz	1	446,00
512.087	87pz	2	249,00

Tabella precisione blocchetti di riscontro

Misura nominale in mm	Oltre	Fino a
10		10
10		25
25		50
50		75
75		100

Grado 0	
Scostamento µm	Planarità µm
± 0,12	0,10
± 0,14	0,10
± 0,20	0,10
± 0,25	0,12
± 0,30	0,12

Grado 1	
Scostamento µm	Planarità µm
± 0,20	0,16
± 0,30	0,16
± 0,40	0,18
± 0,50	0,18
± 0,60	0,20

Grado 2	
Scostamento µm	Planarità µm
± 0,45	0,30
± 0,60	0,30
± 0,80	0,30
± 1,00	0,35
± 1,20	0,35



da € 1246,00

521.047

Codice	Pezzi	Grado	Prezzo €
Composizione B			
521.047	47pz	0	1363,00
522.047	47pz	1	1246,00
Composizione C			
521.048	47pz	0	1363,00
522.048	47pz	1	1246,00
C005.047	Supplemento cert. Accredia		318,00



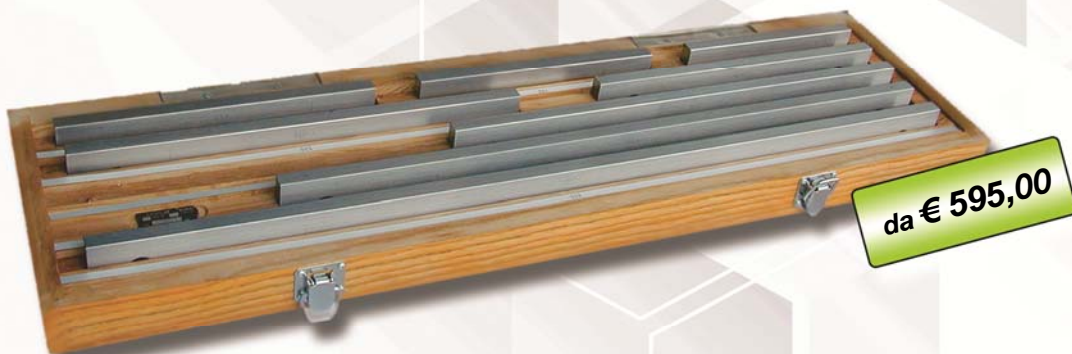

da € 595,00

513.108

Tabella composizione serie blocchetti di riscontro

Comp. K	Passo	N°
25 - 200	25	8

Comp. L	Passo	N°
125 - 200	25	4
250	- - -	1
300 - 500	100	3

Codice	Pezzi	Grado	Prezzo €
Composizione K			
514.008	8pz	0	848,00
514.108	8pz	1	595,00
C514.008	Supplemento cert. Accredia		524,00
Composizione L			
513.008	8pz	0	1584,00
513.108	8pz	1	979,00
C513.008	Supplemento cert. Accredia		640,00

Tabella di precisione blocchetti di riscontro lunghi

Misura nominale in mm	Oltre	Fino a
100	150	
150	200	
200	250	
250	300	
300	400	
400	500	
500	600	

Grado 0	
Scostamento $\mu\text{m}$	Planarità $\mu\text{m}$
$\pm 0,40$	0,14
$\pm 0,50$	0,15
$\pm 0,60$	0,16
$\pm 0,70$	0,19
$\pm 0,90$	0,20
$\pm 1,10$	0,25
$\pm 1,30$	0,25

Grado 1	
Scostamento $\mu\text{m}$	Planarità $\mu\text{m}$
$\pm 0,80$	0,20
$\pm 1,00$	0,25
$\pm 1,20$	0,25
$\pm 1,40$	0,30
$\pm 1,90$	0,30
$\pm 2,20$	0,35
$\pm 2,60$	0,40

Grado 2	
Scostamento $\mu\text{m}$	Planarità $\mu\text{m}$
$\pm 1,60$	0,40
$\pm 2,00$	0,40
$\pm 2,40$	0,45
$\pm 2,80$	0,50
$\pm 3,60$	0,50
$\pm 4,40$	0,60
$\pm 5,00$	0,70

Blocchetti di riscontro con anelli - Controllo calibri e micrometri



da € 189,00

515.010

516.204

Codice	Pezzi	Grado	Prezzo €
Serie 10pz per micrometri 0:25			
2,5 - 5,1 - 7,7 - 10,3 - 12,9 - 15,0 - 17,6 - 20,2 - 22,8 - 25,0			
515.010	10pz	1	189,00
C515.011	Supplemento cert. Accredia		85,00
Serie 3+2pz per calibri 0:200			
Blocchetti 30,0 - 41,3 - 131,4 - Anello $\text{Ø}4 - \text{Ø}25$			
516.204	5pz	1	195,00
C516.204	Supplemento cert. Dakks		250,00

Blocchetti angolari - Controllo squadre e goniometri

ACCREDIA Certificati e RTD a richiesta



da € 287,00

518.501

Codice	Pezzi	Grado	Prezzo €
15°10' - 30°20' - 45°30' - 50° - 60°40' - 75°50' - 90°			
518.501	7pz	1	370,00
518.501A	7pz	2	287,00



006.708

Gli assortimenti possono variare (vedi foto):  
Alcuni vengono forniti con canotti, altri senza  
Il colore del legno degli astucci può variare

Assortimenti 0,01 fino a 1mm

Codice	Utile	Spine	Prog.	Prezzo €
006.697	0,2:0,5	31	0,01	81,00
006.698	0,2:1	81	0,01	167,50
006.699	0,5:1	51	0,01	139,00

Assortimenti 0,01 da 1 a 10mm

Codice	Utile	Spine	Prog.	Prezzo €
006.702	1,01:2	100	0,01	235,00
006.703	2,01:3	100	0,01	235,00
006.704	3,01:4	100	0,01	245,00
006.705	4,01:5	100	0,01	245,00
006.706	5,01:6	100	0,01	245,00
006.707	6,01:7	100	0,01	251,00
006.708	7,01:8	100	0,01	251,00
006.709	8,01:9	100	0,01	259,00
006.710	9,01:10	100	0,01	259,00

Assortimenti 0,01 da 10 a 20mm

Codice	Utile	Spine	Prog.	Prezzo €
006.711	10,01:11	100	0,01	312,00
006.712	11,01:12	100	0,01	312,00
006.713	12,01:13	100	0,01	320,00
006.714	13,01:14	100	0,01	371,00
006.715	14,01:15	100	0,01	371,00
006.716	15,01:16	100	0,01	423,00
006.717	16,01:17	100	0,01	423,00
006.718	17,01:18	100	0,01	468,00
006.719	18,01:19	100	0,01	468,00
006.720	19,01:20	100	0,01	495,00



006.712

Assortimenti decimali

Codice	Utile	Spine	Prog.	Prezzo €
006.700	1:10	91	0,1	230,00
006.761	10:16	61	0,1	229,00
006.762	16:20	41	0,1	216,00



Codice	Ø Spine	Lunghezza	Prezzo €
636.701	0,2:1,5	112	31,00
636.702	1,1:6,5	125	33,00
636.703	5,0:14,0	145	37,00
636.704	12,0:16,5	150	47,50
636.705	14,5:19,5	150	58,00

Codice	Ø Spine	Lunghezza	Prezzo €
636.710	1,0:13,0	113	31,00

Tamponi lisci Passa/Non Passa - Precisione H7 - Nuova produzione di alta qualità

Novità

ACCREDIA Certificati e RTD pagina 79



Codice	Ø Tamponi	Pezzi	Prezzo €
Cofanetti in alluminio o plastica			
575.002Q	3:12	7pz	174,00
575.000Q	3:30	28pz	894,00
575.001Q	32:62	16pz	1075,00

Tamponi filettati Passa/Non Passa - Precisione 6H - Nuova produzione di alta qualità

Novità

ACCREDIA Certificati e RTD pagina 79



Codice	Ø Tamponi	Pezzi	Prezzo €
Cofanetti in alluminio o plastica			
572.100	3:12	7pz	142,00
572.000	3:14	13pz	222,00
572.200	2:30	21pz	399,00

Serie 50 sfere di precisione 0,0025 - Durezza ca. 60 ±2HRC

Novità

ACCREDIA Certificati e RTD pagina 78



Codice	N.coppie	Misure	Prezzo €
006.690	25	Ø1-25	99,50

Tablette girevoli - Contenitore in plastica antipolvere - Filettature e tolleranze ISO

Catalogo 7/15



Codice	Descrizione	Prezzo €
410.350	Filetor	69,00
410.351	Tolerator	69,00

009.699



da € 502,00

009.697



004.951



009.693



Collegando un comparatore della serie 004.95... il display del truschino mostra la somma dei 2 strumenti

Codice	Accessori	Prezzo €
009.697	Cavo truschino-comparatore	19,00

Codice	Utile	Lettura	Precis.	Prezzo €
Comparatori catalogo 4A/21 rev. e promo pagina 34				
004.951	0:12	0,01	10 µm	99,50

Truschini inclusa punta a tracciare e supporto comparatore, optional a richiesta punta a tracciare tonda

Codice	Accessori	Prezzo €
009.699	P.ta tonda 87x37 attacco 8,5x9	40,00

Set completo da 300mm

€ 550,00

Il set comprende 009.693 + 009.697 + 004.951

Codice	Utile	Lettura	Prezzo €
On/off - mm/inch - zero - hold - inc - origin			
009.693	300	0,01	502,00
009.696	600	0,01	703,00

da €197,50



009.653

da € 305,00



009.683

Codice	Utile	Lettura	Prezzo €
On/off - mm/inch - zero - preset+/- ABS - hold			
009.653	300	0,01/inch	197,50
009.655	500	0,01/inch	316,00
009.660	1000	0,01/inch	840,00

Codice	Utile	Lettura	Prezzo €
On/off - mm/inch - zero - preset+/-			
009.683	300	0,01/inch	305,00
009.685	600	0,01/inch	536,00



Codice	Utile	Lettura	Prezzo €
<i>Letture doppio analogico e comparatore centesimale</i>			
006.023	300	mm + 0,01	208,00
006.025	500	mm + 0,01	318,00
006.026	600	mm + 0,01	368,00

Codice	Utile	Lettura	Prezzo €
<i>On/off - mm/inch - zero - preset+/-</i>			
009.023	300	0,01/inch	347,00
009.026	600	0,01/inch	570,00

009.023

006.023

Truschini analogici - Vite micrometrica - Lente ed aste regolabili



Codice	Utile	Lettura	Prezzo €
<i>Il nonio può variare a seconda della disp. a magazzino</i>			
006.003	300	0,02 (0,05)	79,00
006.005	500	0,02 (0,05)	139,50
006.010	1000	0,02 (0,05)	470,00

Codice	Utile	Lettura	Prezzo €
<i>Variante economica del 006.013</i>			
006.043	300	0,02	99,50

006.003

006.013

da € 176,50

Codice	Utile	Lettura	Prezzo €
<i>Asta regolabile - Lente - Vite micrometrica</i>			
006.013	300	0,02	162,00
006.015	500	0,02	217,00
006.016	600	0,02	243,00

**Catalogo 8/4**

**Centratori meccanici - Max 600 giri/min - Finitura brunita, rettificata, ceramici o ricoperti in TIN**

009.682 009.681 653.097 653.096



Codice	Gambo	Cont.Ø	Lungh.	Prezzo €
<b>Centratori con finitura brunita</b>				
009.681	Ø10	10	90	12,50
009.682	Ø10	10+4	90	13,50
<b>Centratori con finitura rettificata</b>				
009.671	Ø10	10	90	19,00
009.672	Ø10	10+4	90	20,00
<b>Centratori amagnetici ricoperti in TIN</b>				
653.096	Ø10	10	90	47,50
653.097	Ø10	10+4	90	49,00
<b>Centratori amagnetici ceramici</b>				
653.091	Ø10	10	90	19,00
653.093	Ø10	10	90	47,00

**Catalogo 8/5**

**Centratori luminosi - Led rosso (009.663 anche sonoro) - A sfioramento, non farli girare**



**Non farli girare in macchina!!!**

Codice	Gambo	Sfera	Lung.	Prezzo €
009.659	Ø20	Ø10	100	75,00
009.662	Ø20	Ø10	160	79,00
009.663	Ø20	Ø10	160	89,00

**Catalogo 8/8**

**Preset altezza - Comparatore Ø40 - Magneti incorporati o a levetta (h 100)**

ACCREDIA Certificati e RDT pagina 79



Codice	Corpo	Piatto	Altezza	Prezzo €
<b>Azzeramento con 2 spine 50/100 incorporate</b>				
009.648	57x65	Ø26	50	99,50
009.649	65x83	Ø26	100	162,00

Codice	Corpo	Piatto	Altezza	Prezzo €
<b>Azzeramento con rotella laterale "preset"</b>				
009.641	57x59	Ø32	50	164,00
009.642	58x80	Ø32	100	247,00

**Novità**

**Preset altezza h50- Analogico con comparatore Ø40 o tipo luminoso**

ACCREDIA Certificati e RDT pagina 79



Codice	Corpo	Piatto	Altezza	Prezzo €
<b>Non utilizzabile su macchine utensili con piano isolato</b>				
009.645	Ø54	Ø11	50	140,00

Codice	Corpo	Piatto	Altezza	Prezzo €
<b>Nuovo modello con contatto maggiorato - Magnetico</b>				
009.644	Ø62	Ø46	50	141,00
009.644N	Ø62	Ø44	50	155,00
009.644Y	Ø62	Ø44	50	174,00

ACCREDIA Certificati e RTD pagina 79

009.652  
vista sup.



009.651

Codice	Corpo	Piatto	Lettura	Prezzo €
009.652	Ø55	Ø25	0,01	108,00

Codice	Corpo	Piatto	Lettura	Prezzo €
009.651	Ø55	Ø25	0,001	134,00
009.654	Ø55	Ø25	0,001	165,00

da € 108,00



009.654

Centratori rotanti - Utilizzo int/est - Comparatore Ø40 - 6 aste tastanti - Corsa 3mm

Catalogo 8/6

ACCREDIA Certificati e RTD a richiesta



Ø10

€ 160,00

653.101

Codice	Attacco	Campo	Comp.	Prezzo €
Rotazione interna - Quadrante sempre in vista				
653.101	Ø10	0-300	Ø40	160,00

Centratori 3D Top H&S analogici o digitali - Corpi in alluminio lavorati dal pieno

Catalogo 8/5

ACCREDIA Certificati e RTD a richiesta



Ø16

richiesta

Ø16



975.901

975.501

Haff Schneider

Codice	Gambo	L totale	Comp.	Prezzo €
Digigraph con doppia lettura - IP67				
975.901	Ø16	134	Ø60	a richiesta
Analogico con scala proporzionale - IP67				
975.501	Ø16	134	Ø60	a richiesta
Codice	Puntalini di ricambio			Prezzo €
975.511	Standard Ø4 L31			a richiesta
975.512	Lunghi Ø6 L56,5			a richiesta

Centratori 3D e puntalini di ricambio FH e TSN - Prezzi a richiesta

Fuori catalogo

ACCREDIA Certificati e RTD a richiesta



Ø20



FH New Generation

Ø12

Ø10



Ø10

FH Centro

richiesta

975.011C-D-E

Puntalini per FH

Codice	Tipo
975.011	Ø4 L27
975.012	Ø8 L69
975.011C	Dritto Ø5
975.011D	Dritto Ø2
975.011E	Curvo Ø5

FH Universal

975.001



975.102

FH Zero Master

975.101

975.001C



Codice	Misura	Peso	Prezzo €
697.900A	300x200x50	9Kg	65,00
697.901A	400x250x60	18Kg	102,00
697.902A	500x315x70	33Kg	150,00
697.903A	630x400x80	60Kg	202,00
697.904A	800x500x100	120Kg	351,00
697.905A	1000x630x140	260Kg	565,00
697.906A	1200x800x160	460Kg	951,00
697.907A	1600x1000x180	860Kg	1395,00



Codice	Piani	Misura	Prezzo €
698.903	630x400	530x350	276,50
698.904	800x500	700x400	288,50
698.905	1000x630	900x530	300,00
698.906	1200x800	1100x700	415,00
698.907	1600x1000	1400x800	461,00

Codice	Descrizione	Prezzo €
698.901	Set 4 piedini antivibranti	39,00



Codice	Misura	Peso	Prezzo €
682.001N	500x50x80	5Kg	205,00
682.002N	750x50x100	10Kg	299,00
682.003N	1000x60x140	23Kg	543,00
682.004N	1500x80x180	40Kg	981,00
682.005N	2000x100x200	80Kg	1388,00



Codice	Misura	Peso	Prezzo €
681.001N	200x150x30	2Kg	130,00
681.002N	300x200x40	5Kg	152,50
681.003N	400x250x50	10Kg	210,50
681.004N	500x315x60	17Kg	248,50
681.005N	630x400x60	28Kg	311,50
681.007N	1000x630x100	117Kg	788,50
681.008N	1200x800x140	210Kg	1736,00
681.009N	1500x1000x160	480Kg	1986,00



Morse rotanti in acciaio - Serraggio a manovella - Predisposizione staffaggio - 0,005/100

Novità



Codice	Apertura	L gan.	h gan.	Prezzo €
008.471	50	50	25	170,50
008.472	75	75	33	206,00
008.473	100	100	38	293,50

Morse in acciaio - Serraggio rapido - Predisposizione staffaggio - 0,005/100

Catalogo 8/9



Codice	Apertura	L gan.	h gan.	Prezzo €
008.529	25	25	10	66,50
008.529A	40	36	25	70,00
008.530	65	50	25	78,00
008.530A	85	63	32	111,50
008.531	100	73	35	130,00
008.532	125	100	45	208,50
008.533	160	125	50	286,50
008.533A	200	150	50	436,50

Morse in acciaio rettificato - Predisposizione staffaggio - 0,005/100

Catalogo 8/9



Codice	Apertura	L gan.	h gan.	Prezzo €
008.516	60	50	25	110,00
008.516A	85	63	32	130,00
008.517	100	73	35	179,50
008.515	128	88	40	204,00
008.518	125	100	45	269,00
008.519	160	125	50	429,00
008.520	210	125	50	459,50

Morse di precisione per trapani - Predisposizione staffaggio

Novità



Codice	Utile	Ponte	Lettura	Prezzo €
008.492	88	100	30	40,50
008.493	120	125	35	67,50
008.495	75	75	35	32,00
008.496	100	100	40	37,00

**Catalogo 8/11**

**Coppia parallele - Temprate per morse - DIN 7168 - (Serie \*HQ alta qualità parallelismo  $\pm 0,01$ )**



008.714

da € 134,50

008.714HQ

ACCREDIA Certificati e RDT a richiesta

Codice	Coppie	Lungh.	Spess.	Prezzo €
008.709	9	100	4	134,50
008.709HQ	9	100	4	171,00
Larghezze: 10-14-18-22-26-30-34-38-42				
008.710	9	160	4	161,00
008.710HQ	9	160	4	228,00
Larghezze: 10-14-18-22-26-30-34-38-42				
008.712HQ	12	120	10	289,00
Larghezze: 14-16-18-20-22-24-26-28-30-32-35-40				
008.714	14	150	10	259,00
008.714HQ	14	150	10	347,00
Larghezze: 14-16-18-20-22-24-26-28-30-32-35-40-45-50				

**Catalogo 6/22**

**Punte a tracciare per frese e trapani - Punta in acciaio temprato - Forza regolabile con molla**



da € 96,00

339.101

339.102

Codice	Passo M	Filetto	Prezzo €
339.101	80(+20)-Ø12	Ø5 - L20	96,00
339.102	80(+20)-Ø16	Ø5 - L20	105,00

**Novità**

**Tavole a croce - Superficie rettificata - Cave a "T" fresate**



€ 145,00

008.521

Codice	Dimensioni	Cave a T	Prezzo €
008.521	185x100x104	3 x 10mm	145,00

**Fuori catalogo**

**Smontaconi inclinabile 90° - Perno a molla - Chiavetta bloccaggio cono**

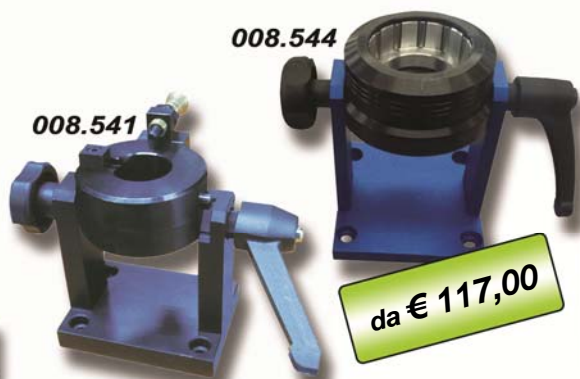

008.544

008.541

da € 117,00

Codice	Standard	Prezzo €
MAS 403 BT		
008.544	ISO 40	117,00

Codice	Standard	Prezzo €
DIN 2080 - DIN 69871 - MAS 403 BT		
008.540	ISO 30	182,00
008.541	ISO 40	163,00
008.542	ISO 50	207,00
HSK - PSC 26623-1 - Capto - KM		
008.546	HSK 63 A-B-C-D-E-F	199,00



Codice	Dimensioni	Cave a T	Prezzo €
008.621	Ø75 x h45	4 x 8mm	99,00
008.622	Ø100 x h55	4 x 8mm	137,00
008.623	Ø150 x h80	4 x 10mm	239,00
008.624	Ø200 x h108	4 x 13mm	390,00



Codice	Dimensioni	Cave a T	Prezzo €
008.631	Ø75 x h56	4 x 8mm	138,00
008.632	Ø100 x h66	4 x 8mm	202,00



Codice	Descrizione	Prezzo €
008.661	Regol. 89-110 x tavole Ø100	76,50
008.662	Regol. 43-80 inclin. x tavole Ø75	89,00
008.663	Regol. 93-125 x tavole Ø100	81,00



Codice	Diam.	Tavola	Fori	Filetto	Prezzo €
008.641	Ø55	Ø75	2	M12	9,00
008.642	Ø55	Ø75	2	M14	9,00
008.643	Ø80	Ø100	4	M12	9,00
008.644	Ø80	Ø100	4	M14	9,00

Codice	Diam.	Tavole	Pinze	Prezzo €
008.651	Ø80	Ø75 e 100	ER16	43,00
008.652	Ø80	Ø75 e 100	ER25	43,00
008.653	Ø80	Ø75 e 100	ER32	43,00

Misure fino a diametro Ø250 a richiesta



Codice	Dimensioni	Cave a T	Prezzo €
008.526N	125x100x80	3 x 10mm	127,50
008.527N	175x125x95	3 x 12mm	175,00
008.528N	250x175x125	3 x 12mm	291,50
008.529N	380x250x170	3 x 12mm	480,50

**Novità**

Tavole inclinabili universali  $\pm 45^\circ$  - Rotazione  $360^\circ$  - Superficie rettificata - Cave a "T" fresate



Codice	Dimensioni	Cave a T	Prezzo €
008.536	125x100	2 x 8mm	188,00
008.537	200x150	3 x 10mm	415,00
008.538	250x200	3 x 12mm	518,00



Codice	Interasse	Punte h	Banco	Prezzo €
008.908	300	100	730	589,00
008.909	500	170	930	830,00
008.910	1000	170	1460	1177,00
008.911	1500	170	1960	1995,00

**Novità**

Banchi di controllo concentricità utensili da taglio - 1 Portacomparatore - Tavola a morsa



Codice	Ø max	Eliche da	mm max	Prezzo €
008.920	150mm	2-10	500mm	3555,00

Tavole verticali - Attacco fisso - Superficie rettificata - Cave a "T" fresate

Novità



008.675



€ 147,50

Codice	Dim.	Cave a T	Corsa	Prezzo €
008.675	125x100	3x16mm	100mm	147,50

Tavole verticali - Attacco rotante - Superficie rettificata - Cave a "T" fresate

Novità



008.680



€ 196,50

Codice	Dim.	Cave a T	Corsa	Prezzo €
008.680	125x100	3x16mm	100mm	196,50

Mini tavole scorrevoli verticali - Attacco fisso - Superficie rettificata - Cava a "T" fresata

Novità



€ 99,50

008.685

Codice	Dim.	Cava a T	Corsa	Prezzo €
008.685	90x50	9mm	70mm	99,50

Morse per tavole verticali - Superficie rettificata - 4 fori montaggio - (008.480 per mini tavole)

Novità

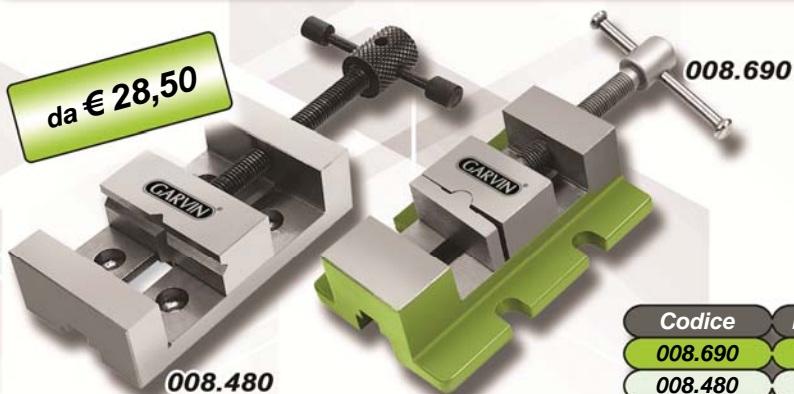

da € 28,50

008.690

008.480

Codice	Lungh.	Prof.	Apertura	Prezzo €
008.690	45	35	30mm	28,50
008.480	50	18	50mm	38,50



**Novità**

Divisori orizzontali/verticali con mandrino a 3 griffe autocentranti - Ghisa



008.670

Codice	Base	Altezza	Ø	Prezzo €
008.670	145x145	80	100	282,00

**Novità**

Morse tonde per tavole rotanti - Acciaio rettificato



008.485

Codice	Ganasce	Apertura	X tavole	Prezzo €
008.485	80x20	40mm	Ø100	32,00
008.486	70x20	28mm	Ø75	35,00

**Novità**

Mandrini per tornio con griffe 3+3 autocentranti - Ghisa



008.600

Codice	Dimensioni	Griffe	Prezzo €
008.600	100mm	3+3	177,00
008.601	150mm	3+3	177,00
008.602	200mm	3+3	260,00
008.603	250mm	3+3	332,00

**Novità**

Mandrini per tornio con griffe 4+4 indipendenti - Ghisa



008.610

**\*Consegna novembre**

Codice	Dimensioni	Griffe	Prezzo €
008.610	100mm	4+4	209,50
008.611	150mm	4+4	229,50
008.612	200mm	4+4	253,00
008.613	250mm	4+4	313,00

ACCREDIA Certificati e RDT a richiesta



Codice	Dimensioni	Misura V	Prezzo €
504.201	50x25x32	25	27,00
504.202	75x32x60	44	42,50
504.203	100x41x65	50	52,00
504.204	125x50x80	50	67,00
504.205	150x63x90	82	112,00

ACCREDIA Certificati e RDT a richiesta



Codice	Dimensioni	Misure 4 V	Prezzo €
508.201	95x35x70	20x30x40x50	76,00
508.202	100x30x100	20x30x40x50	112,50
508.203	120x35x120	30x40x50x60	143,50
508.204	120x60x120	30x40x50x60	169,00
508.205	150x75x150	40x50x60x70	214,00
508.206	200x100x200	50x60x70x80	398,50

ACCREDIA Certificati e RDT a richiesta



Codice	Dimensioni	Misura V	Prezzo €
505.401	75x40x30	5-40	76,50
505.402	100x47x40	5-55	96,50
505.403	150x55x45	5-60	163,00
505.404	200x65x55	5-75	211,50

ACCREDIA Certificati e RDT a richiesta



Codice	Dimensioni	Alberi	Prezzo €
529.501	63x63x50	Ø5-41	145,50
529.501S	Prisma come sopra singolo		78,50
529.502	100x75x75	Ø5-57	324,00
529.502S	Prisma come sopra singolo		179,00



Codice	Dimensioni	Alberi	Prezzo €
529.303	70x63x45	Ø5-38	142,00
529.304	125x88x70	Ø5-54	345,00



Codice	Dimensioni	Larghezza V	Prezzo €
527.104	70x54x73	38/19	191,00
527.104S	Prisma c/s singolo		102,50
527.105	100x70x95	50/19	254,50
527.105S	Prisma c/s singolo		136,50
527.106	150x75x95	55/25	592,50
527.106S	Prisma c/s singolo		314,00



Codice	Dimensioni	Feritoie	Prezzo €
350.501	90x75x63	15	40,00
350.502	115x90x75	15	53,50
350.503	150x125x115	15	76,50
350.504	200x150x125	17	142,00
350.505	300x225x200	25	292,00



Codice	Dimensioni	Feritoie	Prezzo €
350.601	90x75x63	15	41,50
350.602	115x90x75	15	59,00
350.603	150x125x115	15	83,00
350.604	200x150x125	17	147,00
350.605	300x225x200	25	395,00



Misuratori rapidi decimali - Contatti sfere Ø2mm - Lettura 0,1mm

Novità

ACCREDIA Certificati e RDT pagina 78



€ 56,50

Codice	Utile	Bracci	Prezzo €
004.631	0:10	36mm	56,50

Raggimetri e contafiletti - Completamente in acciaio - Raggi e denti fresati

Cat. 7/21-22

ACCREDIA Certificati e RDT pagina 78



da € 4,00

Codice	Lame	Filetto/Utile	Prezzo €
409.111	28	Whitworth 55°	4,00
409.112	24	Metrico 60°	4,00
409.113	52	Ww55°+M60°	5,00
409.114	58	Ww+M+Gas	5,50
417.101	17	1,0-7,0	7,50
417.102	16	7,5-15,0	11,00
417.103	15	15,5-25,0	11,00

Spessimetri a lame coniche - Acciaio - Lunghezza 100 x 12,7

Catalogo 7/19

ACCREDIA Certificati e RDT pagina 78



da € 3,00

Codice	Lame	Misure	Prezzo €
406.113	13	0,05-1,00	3,00
406.120	20	0,05-1,00	4,00
406.132	32	0,03-1,00	6,00

Bobine di nastro calibrato - Acciaio temprato - Custodia di plastica

Catalogo 7/15

ACCREDIA Certificati e RDT a richiesta



da € 7,50

Codice	Spessore	Lunghezza	Prezzo €
742.145	0,05	5mt	7,50
742.150	0,10	5mt	8,00
742.156	0,20	5mt	8,00
742.157	0,25	5mt	8,00
742.158	0,30	5mt	8,00
742.160	0,40	5mt	8,00
742.162	0,50	5mt	8,50



Codice	Pixel	Zoom	Angolo	Prezzo €
Monitor fisso - Sonde da ordinare separatamente				
937.171	320x240	1x - 2x	12,7-305	106,00
Monitor staccabile - Sonde da ordinare separatamente				
937.172	320x240	1x - 4x	12,7-305	219,00

Codice	Pixel	Lung.	Diam.	Prezzo €
Sonde per endoscopi 937.171-172 - Angolo 60°				
937.173	640x480	1000	Ø5,5	128,00
937.174	640x480	3000	Ø5,5	148,00
937.175	640x480	1000	Ø9	57,50
937.176	640x480	3000	Ø9	99,00
937.177	640x480	1000	Ø12	47,00
937.178	640x480	3000	Ø12	74,00

Codice	Lung.	Diam.	Angolo	Prezzo €
Prolunghe per sonde 937.173/178 - Ø18 - Angolo 60°				
937.185	1000	Ø18	60°	13,50
937.186	2000	Ø18	60°	20,00
937.187	3000	Ø18	60°	32,50
937.188	4000	Ø18	60°	44,00

Codice	Diam.	Particolari	Prezzo €
Set accessori per sonde (*1Cappa protettiva - *2 Magnetica *3 e *5 Specchio 90° - *4 Gancio - *6 Gancio magnetico)			
937.161	Ø5,5	1 - 2 - 3	14,50
937.162	Ø9	1 - 2 - 3 - 4	14,50
937.163	Ø12	4 - 5 - 6	14,50



Codice	Pixel	Zoom	Angolo	Prezzo €
Monitor staccabile - Sonde da ordinare separatamente				
937.191	800x480	1x - 4x	12,7-305	299,00

Codice	Pixel	Lung.	Diam.	Prezzo €
Sonde per endoscopi 937.191 - Angolo 60°				
937.195	640x480	1000	Ø9	63,00
937.196	640x480	3000	Ø9	84,50
937.197	640x480	1000	Ø12	49,00
937.198	640x480	3000	Ø12	74,00



App scaricabile gratuitamente

Codice	Pixel	Zoom	Angolo	Prezzo €
Speciale per smartphones - Inclusa sonda Ø9 x L1000				
937.181	640x480	V.Handy	60°	99,00

Bilance - Contapezzi da 3 a 30kg - Doppio display

Catalogo 9/10



ACCREDIA Certificati e RTD a richiesta



Display posteriore

Codice	Capacità	Risoluz.	Piatto	Prezzo €
879.030	3kg	0,1gr	25x18	99,00
879.060	6kg	0,2gr	25x18	99,00
879.150	15kg	1,0gr	25x18	99,00
879.300	30kg	1,0gr	25x18	105,00

Bilance - Piattaforma da 100 a 300kg - Asta inclinabile

Catalogo 9/11



Display EU

ACCREDIA Certificati e RTD a richiesta

Codice	Capacità	Risoluz.	Piatto	Prezzo €
879.410	100kg	20gr	30x40	123,00
879.415	150kg	50gr	30x40	153,50
879.430	300kg	50gr	45x60	254,00

Bilance - Dinamometri per sollevamento pesi da 1000 a 5000kg

Catalogo 9/11



Remote control

ACCREDIA Certificati e RTD a richiesta

Codice	Capacità	Risoluz.	Peso	Prezzo €
879.610	1000kg	500gr	20kg	499,00
879.630	3000kg	1000gr	22kg	606,00
879.650	5000kg	2000gr	24kg	706,00

Durometri a rimbalzo - Sonda intercambiabile tipo D

Novità



ACCREDIA Certificati e RTD a richiesta

Codice	Precis.	Parametri	Prezzo €
901.150	±6HLD	HL-HRC-HRB-HV-HB	599,00

Memoria di 100 gruppi - Spessore minimo 5mm

Codice	Descrizione	Prezzo €
<b>Durometri con display digitale</b>		
906.505	Manuale	1817,00
906.510	Motorizzato	2181,00

Codice	Descrizione	Prezzo €
<b>Durometri con display analogico</b>		
906.501	Manuale	1448,00
906.509	Motorizzato	1816,00



da € 1448,00

906.501  
(906.509 motorizzato)



da € 1817,00

906.505  
(906.510 motorizzato)

Pre carica 10kgf - 98.07N  
Carichi 60kgf - 100kgf - 150kgf

2 provini HRC 1 provino HRB  
1 penetratore diamante 120° + 1 a sfera Ø1,5875  
2 pianetti tondi Ø55 e Ø150 + 1 prismatico

HRA 20:88 - HRB 20:100 - HRC 20:70 - HRD 40:70  
HRF 60:100 - HRG 30:94 - HRH 80:100 - HRK 40:100



€ 3986,00

906.901

Codice	Descrizione	Prezzo €
<b>Durometri digitali e motorizzati</b>		
906.901	Stampante incorporata	3986,00



€ 679,00



901.120

Codice	Parametri	Precis.	Prezzo €
901.120	HL-HRC-HRB-HV-HB	±0,5%	679,00

Compreso software e uscita USB

ACCREDIA Certificati e RDT a richiesta



€ 711,00

Codice	Parametri	Precis.	Prezzo €
901.140	HL-HRC-HRB-HV-HB	±0,5%	711,00

Compreso software e uscita USB

ACCREDIA Certificati e RDT a richiesta



€ 897,00



Codice	Parametri	Precis.	Prezzo €
901.910	HL-HRC-HRB-HV-HB-HS	±0,5%	897,00

Nuovo software e uscita USB - Memo 600 gruppi

ACCREDIA Certificati e RDT a richiesta



da € 1141,00

Bluetooth  
Solo uso stampante



Codice	Parametri	Precis.	Prezzo €
Memoria 600 gruppi di misure - Preset min/max			
Mini USB			
901.101	HL-HRC-HRB-HV-HB-HS	±0,5%	1141,00
Ingresso per sonda esterna - Mini USB - Bluetooth			
901.102	HL-HRC-HRB-HV-HB-HS	±0,5%	1221,00

Codice	Descrizione	Prezzo €
901.501A	Sonda D supplementare con cavetto	263,00
Altri tipi di sonde supplementari a richiesta		
901.103	Stampante Bluetooth	279,50

ACCREDIA Certificati e RDT a richiesta



€ 839,00

Codice	Parametri	Precis.	Prezzo €
901.160	HRC-HRB-HV-HB-HS-HRA-HSD	±0,5%	839,00

Compreso software e uscita USB

**Novità****Durometri a rimbalzo portatili - Display OLED - Sonda tipo D incorporata - Provino escluso**ACCREDIA  Certificati e RTD a richiesta**€ 500,00****€ 72,00****901.130****901.199**

Vedi offerta speciale per un numero limitato di 30 pezzi!!!

Codice	Parametri	Precis.	Prezzo €
Fornito con caricatore USB, spazzolino, laccio e custodia			
<b>901.130</b>	HL-HRC-HRB-HV-HB-HS...	±0,5%	<b>500,00</b>
<b>901.199</b>	Provino di taratura per durometri		<b>72,00</b>

**Novità****Misuratori di riporti (spessori) - Incluso nuovo software**ACCREDIA  Certificati e RTD a richiesta**da € 592,00****915.920**

Nuovo software e uscita USB - Memo 1560 gruppi

Codice	Substr.	µm	Precis.	Prezzo €
<b>915.920</b>	Ferroso	0:1250	±2%+1	<b>610,00</b>
<b>915.921</b>	Non ferr.	0:1250	±2%+1	<b>592,00</b>
Codice	Sonde intercambiabili		Prezzo €	
<b>915.928</b>	Sonda di ricambio/add. Fe		<b>160,00</b>	
<b>915.929</b>	Sonda di ricambio/add. NFe		<b>160,00</b>	

**Catalogo 9/16****Misuratori di riporti (spessori) - Sonda incorporata Fe/NFe**ACCREDIA  Certificati e RTD a richiesta**€ 296,00****915.205**

Area minima Ø10mm  
 Curvatura convessa 5 - concava 20  
 Inclusi 2 provini Fe e NFe + 5 spessori  
 Risoluzione 0,1µm

Codice	µm	Precisione	Prezzo €
<b>915.205</b>	0:1250	±(1:3%)+1	<b>296,00</b>

**Catalogo 9/18****Misuratori di riporti (spessori) - Inclusa 1 sonda intercambiabile (Fe oppure NFe)**ACCREDIA  Certificati e RTD a richiesta**da € 530,00****915.238/39****915.232-233**

Compreso software e uscita USB - Memo 500 gruppi

Codice	Substr.	µm	Precis.	Prezzo €
<b>915.232</b>	Ferroso	0:1250	±3%+1	<b>530,00</b>
<b>915.233</b>	Non ferr.	0:1250	±3%+1	<b>530,00</b>
Codice	Sonde intercambiabili		Prezzo €	
<b>915.238</b>	Sonda di ricambio/add. Fe		<b>159,00</b>	
<b>915.239</b>	Sonda di ricambio/add. NFe		<b>159,00</b>	

Durometri digitali e provini - Shore A - D - C

Catalogo 9/16

ACCREDIA Certificati e RDT a richiesta



€ 93,00

009.620

009.621

009.622

Punta Ø1,25x L2,5  
smussata 35  
Ø0,79 penetrante

Punta Ø2,5x L2,5  
sferica  
SR 5,5 penetrante

Punta Ø1,25x L2,5  
smussata 30°  
SR 0,1 penetrante

Codice	Campo	Precis.	Letture	Prezzo €
Shore A per gomma soffice				
009.620	0:100 HA	2%	0,5 HA	93,00
Shore D per gomma dura e materiali plastici				
009.621	0:100 HD	2%	0,5 HD	93,00
Shore C per gomma piuma e spugna				
009.622	0:100 HC	2%	0,5 HC	93,00

Codice	Durezze nominali	Prezzo €
7 provini colorati Shore A		
009.600	34 - 40 - 55 - 67 - 78 - 85 - 91	112,50
3 provini colorati Shore D		
009.601	28 - 42 - 83	75,00

Fonometri digitali - Classe II (A) - Risoluzione 0,1db

Catalogo 9/29

ACCREDIA Certificati e RDT a richiesta



982.410

€ 120,50

Codice	Portata dB	Hz	Prezzo €						
982.410	30:80-50:100-80:130	31,5:8000	120,50						
Precisione pesature tipo A (simili all'orecchio umano)									
KHz	0,03	0,06	0,12	0,25	0,5	1	2	4	8
db±	3	2	1,5	1,5	1,5	1,5	2	3	5

Fonometri digitali - Classe I (A+C) - Inclusa micro SD 8GB - Risoluzione 0,1db

Catalogo 9/29

ACCREDIA Certificati e RDT a richiesta



980.601

€ 327,50



RS232 + USB



Micro SD 8 GB

Classe I

Codice	Portata dB	Hz	Prezzo €						
980.601	30:80-50:100-80:130	31,5:16000	327,50						
Precis. pesature A (orecchio umano) e C (rumore macchine)									
KHz	0,03	0,06	0,12	0,25	0,5	1	2	4	8
db±	2	1,5	1,5	1,4	1,4	1,1	1,6	1,6	2,1

Rugosimetri - Misurazione esterni - LCD Oled - Risoluzione 0,01µm

Catalogo 9/16

ACCREDIA Certificati e RDT a richiesta



€ 1233,00

935.452

Codice	Raµm	Rzµm	Campionam.	Prezzo €
935.452	0,05:15	0,1:50	0,25-0,8-2,5	1233,00

Precisione < ±10% - Ripetibilità < 12%  
4 parametri Ra, Rz, Rq, Rt

**Novità**

**Rugosimetri con sonda estraibile - Misurazione interni ed esterni - LCD - Risoluzione 0,001µm**



ACCREDIA Certificati e RDT a richiesta



Display LCD



Sonda estraibile

Codice	Campo misura	Campionam.	Prezzo €
935.462	160µm (-80/+80µm)	0,25-0,8-2,5	2486,00

Precisione  $\leq \pm 7\%$  - Ripetibilità  $< 6\%$  - Parametri Ra, Rz, Rq, Rt, Rp, Rv, R3z, R3y, Rz(JIS), Rs, Rsk, Rsm, Rku, Rmr, Ry, Rmax, Rc - Velocità da 0,135 a 1mm/sec

**Novità**

**Rugosimetri - Misurazione esterni - LCD Oled - Risoluzione 0,01µm**

ACCREDIA Certificati e RDT a richiesta



Codice	Raµm Rzµm	Campionam.	Prezzo €
935.110	0,05:10 - 0,1:50	0,25-0,8-2,5	999,00

Precisione 0,01µm - Ripetibilità  $< 12\%$   
4 parametri Ra, Rz, Rq, Rt  
Valutazione L0,25 e 4mm - Velocità 1mm/sec

**Catalogo 9/21**

**Rugosimetri - Misurazione interni ed esterni - LCD Oled - Risoluzione 0,001µm**

ACCREDIA Certificati e RDT a richiesta



Codice	Raµm Rzµm	Campionam.	Prezzo €
935.402	0,005:10-0,02:160	0,25-0,8-2,5	1798,00

Precisione  $< \pm 8\%$  - Ripetibilità  $< 6\%$   
Ra 0,005 - Rz 0,02 + altri 11 parametri  
Valutazione L1,25-4-5mm - Memoria per 100 gruppi

**Catalogo 9/21**

**Rugosimetri - Misurazione interni ed esterni - LCD Oled - Risoluzione 0,001µm**

ACCREDIA Certificati e RDT a richiesta



Sonda



Codice	Raµm Rzµm	Campionam.	Prezzo €
935.210	0,005:16-0,02:160	0,25-0,8-2,5-8	1616,00

Precisione  $< \pm 10\%$  - Ripetibilità  $< 6\%$   
Ra 0,005 - Rz 0,02 + altri 11 parametri  
Valutazione L1 e 4mm



ACCREDIA Certificati e RDT a richiesta



Codice	Utile	Ponte	Letture	Prezzo €
945.342	0,75:300	1000:9999	±(1%H+0,1)	775,00

Memoria 2000 rilevamenti  
Piastrina di azzeramento incorporata

ACCREDIA Certificati e RDT a richiesta



Nuovo software + uscita USB + 1 sonda dritta ed 1 ad angolo

Codice	Utile	Ponte	Letture	Prezzo €
945.930	0,75:300	1000:9999	±(0,5%+0,01)	607,00

Memoria 2000 rilevamenti  
Piastrina di azzeramento incorporata

ACCREDIA Certificati e RDT a richiesta



Compreso software ed uscita USB

Codice	Utile	Ponte	Letture	Prezzo €
945.352	0,75:300	1000:9999	±(1%H+0,1)	964,00

Memoria 2000 rilevamenti  
Piastrina di azzeramento a 4 valori inclusa

ACCREDIA Certificati e RDT a richiesta



Codice	Utile	Ponte	Letture	Prezzo €
945.332	0,75:300	1000:9999	±(1%H+0,1)	493,00

Memoria 2000 rilevamenti  
Piastrina di azzeramento incorporata



ACCREDIA Certificati e RTD a richiesta



Software ed uscita USB  
1 sonda diritta + 1 sonda ad angolo  
Calibrazione automatica sui provini  
Alta frequenza di campionamento con rumore basso

Codice	Campo	m/sec	Prec.	MHz	Prezzo €
945.510	0:6000	>11000	≤3%	0,4:15	2884,00

Risoluzione 0,1mm (2,5:100mm, oltre 1mm)  
Errore orizzontale lineare ≤0,1%  
Velocità del suono 1000m/s : 15000m/s  
Memo 980 scansioni

Novità

ACCREDIA Certificati e RTD a richiesta



Nuovo software ed uscita USB  
1 sonda diritta + 1 sonda ad angolo  
Calibrazione automatica sui provini  
Alta frequenza di campionamento con rumore basso

Codice	Campo	m/sec	Prec.	MHz	Prezzo €
945.953	0:10000	>20000	≤2%	0,5:20	4693,00

Risoluzione 0,1mm (2,5:100mm, oltre 1mm)  
Errore orizzontale lineare ≤0,1%  
Velocità del suono 100m/s : 20000m/s  
Memo 1000 scansioni

ACCREDIA Certificati e RTD a richiesta



Codice	Misurazioni	Prezzo €
966.501	Fono-Igro-Anemo-Lux-Termo	119,00

Temperature con sonda K (esclusa) -50:1300°C

Fonometro 35:130dB (Classe II)  
Igmometro 10:95% e temperature 0:50°C  
Luxmetro 0:20000Lux  
Anemometro 0,4:30m/s - 1,4:108km/h

RS232 + USB

ACCREDIA Certificati e RTD a richiesta



Codice	mGauss	µTesla	Prezzo €
955.502	200-2000-20000	20-200-2000	175,50

Misuratori con sonda 3 assi esterna

ACCREDIA Certificati e RTD a richiesta



€ 317,50

946.501

€ 161,50



946.505

Ellisse asse lunga 8, asse corta 4 - Memoria 100 gruppi

Codice	Gloss	Risoluz.	Errore	Prezzo €
946.501	200 GU	0,1 GU	1 GU	317,50
946.505	Stampante termica			161,50

ACCREDIA Certificati e RTD a richiesta



da € 440,00

946.511



Gloss	Gloss	Gloss
2000	1000	160
Angolo 20°	Angolo 60°	Angolo 85°
Elisse 10x10	Elisse 9x15	Elisse 5x38
Risoluzione 1,0GU	Risoluzione 0,1GU	Risoluzione 0,1GU

Codice	Gloss	Risoluz.	Errore	Prezzo €
Strumento a 60° per vernici				
946.511	1000 GU	0,1 GU	1 GU	440,00
Strumenti a 20-60-85° per vernici e metalli lucidi				
946.531	2000 GU	0,1 GU	1 GU	1199,00

ACCREDIA Certificati e RTD a richiesta



€ 585,00

946.911



RS232 + USB

Campo spettrale 400:700nm  
Risoluzione RGB 1 - HSL 0,001  
Applicazioni: superfici non luminose (valori assoluti)  
Superfici luminose (misurazioni relative a confronto)

Codice	RGB	HSL	Illumin.	Prezzo €
946.911	0:1023	0:1000	45°	585,00

ACCREDIA Certificati e RTD a richiesta



€ 197,50

947.701



RS232 + USB



Micro SD 8 GB

Risoluzione Lux 1 (2000) - 10 (20000) - 100 (100000)  
Temperature con sonde K -50:1300°C

Codice	Campi di misura Lux	Precis.	Prezzo €
967.701	2000-20000-100000	±4%+dig	197,50



Codice	Kg	Risoluz.	Precis.	Prezzo €
970.620	20	10g	0,5%+1d	363,00



Micro SD 8 GB

Codice	Descrizione	Prezzo €
970.490	Stativo h500 - Base 250x230	599,50
970.491	Morsetto blocca oggetti	28,00



RS232 + USB

Codice	Kg	Risoluz.	Precis.	Prezzo €
970.405	5	1g	0,4%+1d	336,50
970.420	20	10g	0,5%+1d	363,00
970.500	100	50g	0,5%+1d	453,00



Codice	Ottico	Contatto	V.m/min	Prezzo €
947.501	5:99999	0,5:19999	0,05:1999	219,00



Risoluzione 0,1 RPM < 1000 RPM (oltre 1 RPM)  
 Risoluzione contametri 0,01m/min < 100m/min (oltre 0,1)  
 Precisione ± (0,05% + 1 digit)

Codice	Ottico	Contatto	V.m/min	Prezzo €
947.601	10:99999	0,5:19999	0,05:1999	285,50

ACCREDIA Certificati e RTD a richiesta



RS232 + USB



Micro SD 8 GB

Gamma di frequenza 10Hz : 1kHz  
Errore dati  $\leq 0,1\%$  di tutti i dati memorizzati

Codice	Acc m/s <sup>2</sup>	Vel mm/s	Spost.	Prezzo €
972.501	0,5:199,9	0,5:199,9	1,999mm	379,00

Torsiometri digitali - Mandrino  $\varnothing 1,5-13\text{mm}$  - Uscita USB e RS 232

ACCREDIA Certificati e RTD a richiesta



RS232 + USB

Data-Hold - min/max - Peak/Hold  
Unità Ncm - kgfcm - lbf·in  
Protezione sovraccarica max 150%  
Mantenimento valore di picco

Codice	Range	Risoluz.	Precis.	Prezzo €
971.501	147,1	0,1:1Ncm	$\pm 1,5\% + 5d$	399,00

Termometri digitali - Raggi infrarossi - Puntatore laser

ACCREDIA Certificati e RTD pagina 78

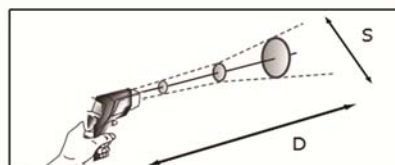

Indica il  $\varnothing$  della superficie misurata S rispetto alla distanza D

Codice	Range °C	D:S	Precis.	Prezzo €
Modello medio con ingresso sonde K (-50:1230°C)				
960.101	-20:400	7:1	$\pm 3\%$	221,50

Puntatore laser - Memorizzazione min/max - Funzione Hold

Codice	Range °C	D:S	Precis.	Prezzo €
Modello Top della gamma con ingresso sonde K				
960.201	-30:1000	50:1	$\pm 2\%$	280,00

2 puntatori laser - Memorizzazione min/max - Funzione Hold

Codice	Range °C	D:S	Precis.	Prezzo €
Modello di dimensioni ridotte				
960.301	-30:305	7:1	$\pm 3\%$	99,50

Puntatore laser



Codice	Sonda	Range	Prezzo €
Sonde K per tutti i termometri			
963.002	Standard	-50:900°C	67,00
963.003	Alte temper.	-50:1200°C	101,00
963.004	Superficie	-50:400°C	132,00

Codice	Range	Precisione	Prezzo €
Termometro con doppio ingresso solo per sonde K			
963.916	-50:1230°C	±1%+1°C	159,00

Codice	Range	Precisione	Prezzo €
Termometro doppio ingresso per sonde 100Ohm platino o K			
964.917	-100:1370°C	±0,1% o 0,2°C	217,00
964.100	Sonda 100Ohm x 964 - 50:400°C		135,00



RS232 + USB

964.917 e 965.901 possono utilizzare anche le Sonde K perdendo leggermente di precisione

Codice	Range	Precisione	Prezzo €
Termometro con 4 ingressi per sonde 100Ohm platino o K			
965.901	-250:1370°C	±0,5%	196,50
964.101	Sonda 100Ohm x 965 - 50:400°C		135,00



RS232 + USB



Micro SD 8 GB

Codice	Velocità dell'aria (u.m.)	Prezzo €
Anemometro con carta SD per sonde K temperatura		
939.501	m/s-km/h-mile/h-Knot-ft/min	259,00

da € 67,00

€ 159,00

€ 217,00

€ 196,50

€ 259,00



996.801-802

da € 81,00



996.801 Neon



996.802 90 Led

Codice	ØLente	Luce	Watt	Prezzo €
996.801	127	Neon	22W	81,00
996.802	127	90 Led	7W	95,00
Lente fissa a 5 diottrie				



996.804

€ 33,50



da € 69,50

Codice	Descrizione	Prezzo €
996.803	Stativo a 4 ruote girevoli	30,00
996.804	Stativo tondo da tavolo	33,50



Lente intercambiabile

996.901-902

Codice	ØLente	Luce	Watt	Prezzo €
996.901	127	Neon	22W	69,50
996.902	127	60 Led	12W	73,00
Lente fissa a 8 diottrie				



€ 30,00

Codice	ØLente	Luce	Watt	Prezzo €
996.903	127	60 Led	12W	90,00
996.904	150	60 Led	12W	111,00
2 lenti intercambiabili a 3+20 e 5+20 diottrie				
Con dimmer solo modello 996.904				

da € 90,00

€ 13,00



996.905

Codice	ØLente	Luce	Watt	Prezzo €
996.905	150	---	---	13,00
Solo lente intercambiabile a 8 - 10 - 12 - 15 diottrie				



996.803

996.903-904

Codice	Altezza	Corpo	Consumo	Prezzo €
<i>Alogena 24V - 50W</i>				
996.821	110	Ø90	50W	73,00
996.820	650	Ø90	50W	141,00



Codice	Altezza	Corpo	Consumo	Prezzo €
<i>Alogena 24V con griglia di protezione - IP54 - 50W</i>				
996.811	110	Ø125	50W	93,50
996.810	890	Ø125	50W	151,50



Codice	Altezza	Corpo	Consumo	Prezzo €
<i>Led 24V - IP54 - 8W</i>				
996.831	110	Ø125	8W	186,00
996.830	890	Ø125	8W	235,50



# PROMO 2019/20

## CERTIFICAZIONI ACCREDIA e RAPPORTI DI TARATURA



Precedentemente



*Alcuni articoli esteri possono essere consegnati in alternativa  
con certificati tedeschi o inglesi con la stessa validità*



Precedentemente

**DKD**



*Consegna media 10/15gg*

*I prezzi includono i trasporti andata e ritorno da noi al  
laboratorio, non quelli dall'utensiliere a noi e viceversa.*



**PREZZI RIFERITI A CERTIFICAZIONE ACCREDIA E RAPPORTI DI TARATURA**

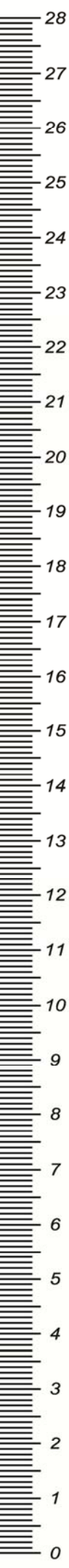

<b>C001.150</b>	<b>ACCREDIA</b> <small>UNITE ITALIANO DI ACCREDITAMENTO</small>	<b>Calibri nonio/orologio/digitali fino 150</b>	<b>90,00</b>
<b>C001.200</b>	<b>ACCREDIA</b> <small>UNITE ITALIANO DI ACCREDITAMENTO</small>	<b>Calibri nonio/orologio/digitali oltre 150 fino 200</b>	<b>92,00</b>
<b>C001.300</b>	<b>ACCREDIA</b> <small>UNITE ITALIANO DI ACCREDITAMENTO</small>	<b>Calibri nonio/orologio/digitali oltre 200 fino 300</b>	<b>115,00</b>
<b>R001.150</b>	<b>R.D.T.</b>	<b>Calibri nonio/orologio/digitali fino 150</b>	<b>31,00</b>
<b>R001.200</b>	<b>R.D.T.</b>	<b>Calibri nonio/orologio/digitali oltre 150 fino 200</b>	<b>33,00</b>
<b>R001.300</b>	<b>R.D.T.</b>	<b>Calibri nonio/orologio/digitali oltre 200 fino 300</b>	<b>49,00</b>



<b>C001.500</b>	<b>ACCREDIA</b> <small>UNITE ITALIANO DI ACCREDITAMENTO</small>	<b>Calibri nonio/digitali oltre 300 fino 500</b>	<b>125,00</b>
<b>C001.1000</b>	<b>ACCREDIA</b> <small>UNITE ITALIANO DI ACCREDITAMENTO</small>	<b>Calibri nonio/digitali oltre 500 fino 1000</b>	<b>260,00</b>
<b>R001.500</b>	<b>R.D.T.</b>	<b>Calibri nonio/digitali oltre 300 fino 500</b>	<b>90,00</b>
<b>R001.800</b>	<b>R.D.T.</b>	<b>Calibri nonio/digitali oltre 500 fino 800</b>	<b>118,00</b>
<b>R001.1000</b>	<b>R.D.T.</b>	<b>Calibri nonio/digitali oltre 800 fino 1000</b>	<b>133,00</b>
<b>R001.3000</b>	<b>R.D.T.</b>	<b>Calibri nonio/digitali oltre 1000 fino 3000</b>	<b>richiesta</b>



<b>C002.025</b>	<b>ACCREDIA</b> <small>UNITE ITALIANO DI ACCREDITAMENTO</small>	<b>Micrometri nonio/contatore/digitali 0:25</b>	<b>81,00</b>
<b>C002.050</b>	<b>ACCREDIA</b> <small>UNITE ITALIANO DI ACCREDITAMENTO</small>	<b>Micrometri nonio/contatore/digitali 25:50</b>	<b>92,00</b>
<b>C002.075</b>	<b>ACCREDIA</b> <small>UNITE ITALIANO DI ACCREDITAMENTO</small>	<b>Micrometri nonio/contatore/digitali 50:75</b>	<b>103,00</b>
<b>C002.100</b>	<b>ACCREDIA</b> <small>UNITE ITALIANO DI ACCREDITAMENTO</small>	<b>Micrometri nonio/contatore/digitali 75:100</b>	<b>114,00</b>

**Riscontri non compresi - Non viene controllata la planarità**

<b>R002.025</b>	<b>R.D.T.</b>	<b>Micrometri nonio/contatore/digitali 0:25</b>	<b>29,00</b>
<b>R002.050</b>	<b>R.D.T.</b>	<b>Micrometri nonio/contatore/digitali 25:50</b>	<b>32,00</b>
<b>R002.075</b>	<b>R.D.T.</b>	<b>Micrometri nonio/contatore/digitali 50:75</b>	<b>34,00</b>
<b>R002.100</b>	<b>R.D.T.</b>	<b>Micrometri nonio/contatore/digitali 75:100</b>	<b>36,00</b>
<b>R002.125</b>	<b>R.D.T.</b>	<b>Micrometri nonio/contatore/digitali 100:125</b>	<b>47,00</b>
<b>R002.150</b>	<b>R.D.T.</b>	<b>Micrometri nonio/contatore/digitali 125:150</b>	<b>51,00</b>
<b>R002.175</b>	<b>R.D.T.</b>	<b>Micrometri nonio/contatore/digitali 150:175</b>	<b>56,00</b>
<b>R002.200</b>	<b>R.D.T.</b>	<b>Micrometri nonio/contatore/digitali 175:200</b>	<b>61,00</b>
<b>R002.225</b>	<b>R.D.T.</b>	<b>Micrometri nonio/contatore/digitali 200:225</b>	<b>69,00</b>
<b>R002.250</b>	<b>R.D.T.</b>	<b>Micrometri nonio/contatore/digitali 225:250</b>	<b>75,00</b>
<b>R002.275</b>	<b>R.D.T.</b>	<b>Micrometri nonio/contatore/digitali 250:275</b>	<b>83,00</b>
<b>R002.300</b>	<b>R.D.T.</b>	<b>Micrometri nonio/contatore/digitali 275:300</b>	<b>92,00</b>



<b>C002.025R</b>	<b>ACCREDIA</b> <small>UNITE ITALIANO DI ACCREDITAMENTO</small>	<b>Riscontri 25</b>	<b>79,00</b>
<b>C002.050R</b>	<b>ACCREDIA</b> <small>UNITE ITALIANO DI ACCREDITAMENTO</small>	<b>Riscontri 50</b>	<b>81,00</b>
<b>C002.100R</b>	<b>ACCREDIA</b> <small>UNITE ITALIANO DI ACCREDITAMENTO</small>	<b>Riscontri 75 o 100</b>	<b>88,00</b>
<b>C002.200R</b>	<b>ACCREDIA</b> <small>UNITE ITALIANO DI ACCREDITAMENTO</small>	<b>Riscontri oltre 100 fino 200</b>	<b>115,00</b>
<b>C002.300R</b>	<b>ACCREDIA</b> <small>UNITE ITALIANO DI ACCREDITAMENTO</small>	<b>Riscontri oltre 200 fino 300</b>	<b>125,00</b>

**Verifica della misura attraverso 1 punto centrale**

<b>R002.050R</b>	<b>R.D.T.</b>	<b>Riscontri 25 o 50</b>	<b>19,00</b>
<b>R002.100R</b>	<b>R.D.T.</b>	<b>Riscontri 75 o 100</b>	<b>21,00</b>
<b>R002.200R</b>	<b>R.D.T.</b>	<b>Riscontri oltre 100 fino 200</b>	<b>36,00</b>
<b>R002.300R</b>	<b>R.D.T.</b>	<b>Riscontri oltre 200 fino 300</b>	<b>49,00</b>

C002.401	ACCREDIA	Micrometri nonio/orol. incudini regolabili 300:400	253,00
C002.501	ACCREDIA	Micrometri nonio/orol. incudini regolabili 400:500	285,00
C002.601	ACCREDIA	Micrometri nonio/orol. incudini regolabili 500:600	290,00
C002.701	ACCREDIA	Micrometri nonio/orol. incudini regolabili 600:700	295,00
C002.801	ACCREDIA	Micrometri nonio/orol. incudini regolabili 700:800	315,00
C002.901	ACCREDIA	Micrometri nonio/orol. incudini regolabili 800:900	325,00
C002.1001	ACCREDIA	Micrometri nonio/orol. incudini regolabili 900:1000	340,00

Riscontri non compresi - Non viene controllata la planarità

R002.401	R.D.T.	Micrometri nonio/orol. incudini regolabili 300:400	117,00
R002.501	R.D.T.	Micrometri nonio/orol. incudini regolabili 400:500	147,00
R002.601	R.D.T.	Micrometri nonio/orol. incudini regolabili 500:600	161,00
R002.701	R.D.T.	Micrometri nonio/orol. incudini regolabili 600:700	177,00
R002.801	R.D.T.	Micrometri nonio/orol. incudini regolabili 700:800	191,00
R002.901	R.D.T.	Micrometri nonio/orol. incudini regolabili 800:900	199,00
R002.1001	R.D.T.	Micrometri nonio/orol. incudini regolabili 900:1000	215,00

C002.400R	ACCREDIA	Riscontri oltre 300 fino 400	121,00
C002.500R	ACCREDIA	Riscontri oltre 400 fino 500	125,00
C002.600R	ACCREDIA	Riscontri oltre 500 fino 600	135,00
C002.650R	ACCREDIA	Riscontri oltre 600 fino 650	140,00

Verifica della misura attraverso 1 punto centrale

R002.400R	R.D.T.	Riscontri oltre 300 fino 400	60,00
R002.500R	R.D.T.	Riscontri oltre 400 fino 500	73,00
R002.600R	R.D.T.	Riscontri oltre 500 fino 600	99,00
R002.700R	R.D.T.	Riscontri oltre 600 fino 675	103,00
R002.1000R	R.D.T.	Riscontri oltre 675 fino 1000	175,00

C002.241	ACCREDIA	Testine micrometriche a nonio 0:25 o 0:50	89,00
C009.281	ACCREDIA	Testine micrometriche digitali 0:25 o 0:50	92,00

R002.241	R.D.T.	Testine micrometriche a nonio 0:25 o 0:50	32,00
R009.281	R.D.T.	Testine micrometriche digitali 0:25 o 0:50	35,00

C002.181	ACCREDIA	Micrometri di profondità 0:25 fisso o con 1 asta	125,00
C002.181P	ACCREDIA	Ogni asta supplementare fino a 300	50,00

R002.181	R.D.T.	Micrometri di profondità 0:25 o 0:50	60,00
R002.183	R.D.T.	Micrometri di profondità 0:100	90,00
R002.184	R.D.T.	Micrometri di profondità 0:200	125,00
R002.188	R.D.T.	Micrometri di profondità 0:300	160,00

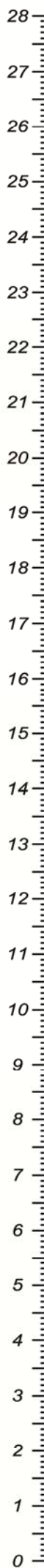



CS576.001	ACCREDIA	Anelli lisci di azzeramento Ø5>150	61,00
CS576.005	ACCREDIA	c/s quantità minima 5pz max 20pz cad.	richiesta
CS576.020	ACCREDIA	c/s quantità superiore a 20pz	richiesta

Verifica standard - 1Ø sulla mezzeria (tot. 1)

RS576.015	R.D.T.	Anelli lisci di azzeramento Ø1,5>20	21,00
RS576.200	R.D.T.	Anelli lisci di azzeramento Ø20>50	25,00
RS576.500	R.D.T.	Anelli lisci di azzeramento Ø50>75	31,00
RS576.750	R.D.T.	Anelli lisci di azzeramento Ø75>100	36,00
RS577.000	R.D.T.	Anelli lisci di azzeramento Ø100>150	43,00
RS577.500	R.D.T.	Anelli lisci di azzeramento Ø150>200	52,00

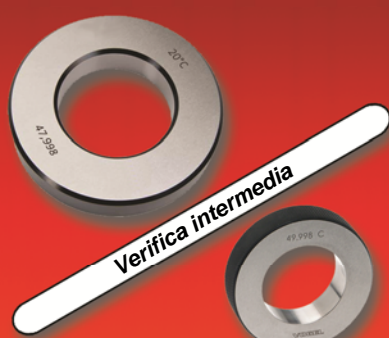

CI576.001	ACCREDIA	Anelli lisci di azzeramento Ø5>150	81,00
CI576.005	ACCREDIA	c/s quantità minima 5pz max 20pz cad.	richiesta
CI576.020	ACCREDIA	c/s quantità superiore a 20pz	richiesta

Verifica intermedia - 3Ø a 3 altezze diverse (tot. 3)

RI576.015	R.D.T.	Anelli lisci di azzeramento Ø1,5>20	23,00
RI576.200	R.D.T.	Anelli lisci di azzeramento Ø20>50	27,00
RI576.500	R.D.T.	Anelli lisci di azzeramento Ø50>75	33,00
RI576.750	R.D.T.	Anelli lisci di azzeramento Ø75>100	38,00
RI577.000	R.D.T.	Anelli lisci di azzeramento Ø100>150	45,00
RI577.500	R.D.T.	Anelli lisci di azzeramento Ø150>200	54,00



CC576.001	ACCREDIA	Anelli lisci di azzeramento Ø5>150	richiesta
-----------	----------	------------------------------------	-----------

Verifica completa - 3Ø a 3 altezze diverse + ovalità 3Ø a 90° (tot. 6)



LAS-6001	ACCREDIA	Supplemento obbligatorio serializzazione laser	2,45
C006.001	ACCREDIA	Spine calibrate singole 1-4pz grado 1 o 2 cad.	54,00
C006.010	ACCREDIA	Serie spine calibrate 10pz grado 1 o 2	97,00
C006.695	ACCREDIA	Serie spine calibrate 20pz grado 1 o 2	155,00
C006.702	ACCREDIA	Serie spine calibrate 100pz grado 1 o 2 Ø1-10	716,00
C006.717	ACCREDIA	Serie spine calibrate 100pz grado 1 o 2 Ø11-20	725,00

Verifica standard (per verifica intermedia +20% - verifica completa +50%)

R006.001	R.D.T.	Spine calibrate singole 1-4pz grado 1 o 2 cad.	7,80
R006.010	R.D.T.	Serie spine calibrate 10pz grado 1 o 2	53,00
R006.695	R.D.T.	Serie spine calibrate 20pz grado 1 o 2	101,00
R006.702	R.D.T.	Serie spine calibrate 100pz grado 1 o 2 Ø1-10	312,00
R006.717	R.D.T.	Serie spine calibrate 100pz grado 1 o 2 Ø11-20	321,00

**PREZZI RIFERITI A CERTIFICAZIONE ACCREDIA E RAPPORTI DI TARATURA**



C005.032	ACCREDIA	Serie 32 blocchetti di riscontro gr.0-1-2 D1	216,00
C005.047	ACCREDIA	Serie 47 blocchetti di riscontro gr.0-1-2 D1	318,00
C005.087	ACCREDIA	Serie 87 blocchetti di riscontro gr.0-1-2 D1	594,00
C005.103	ACCREDIA	Serie 103 blocchetti di riscontro gr.0-1-2 D1	695,00

**D1 Verifica in 1 punto centrale - D2 Verifica in 5 punti incl. variazione lunghezza**

C555.032	ACCREDIA	Serie 32 blocchetti di riscontro gr.0-1-2 D2	262,00
C555.047	ACCREDIA	Serie 47 blocchetti di riscontro gr.0-1-2 D2	386,00
C555.087	ACCREDIA	Serie 87 blocchetti di riscontro gr.0-1-2 D2	714,00
C555.103	ACCREDIA	Serie 103 blocchetti di riscontro gr.0-1-2 D2	845,00



C500.000	ACCREDIA	Blocchetti singoli 0,5-100 1pz gr.0-1-2 D1	37,00
C500.003	ACCREDIA	Blocchetti singoli 0,5-100 3pz gr.0-1-2 D1	92,00
C500.005	ACCREDIA	Blocchetti singoli 0,5-100 5pz gr.0-1-2 D1	138,00
C500.006	ACCREDIA	Blocchetti singoli 0,5-100 6 pz (5+1) gr.0-1-2 D1	175,00

**D1 Verifica in 1 punto centrale - D2 Verifica in 5 punti incl. variazione lunghezza**

C555.000	ACCREDIA	Blocchetti singoli 0,5-100 1pz gr.0-1-2 D2	41,00
C555.003	ACCREDIA	Blocchetti singoli 0,5-100 3pz gr.0-1-2 D2	98,00
C555.005	ACCREDIA	Blocchetti singoli 0,5-100 5pz gr.0-1-2 D2	150,00
C555.006	ACCREDIA	Blocchetti singoli 0,5-100 6pz (5+1) gr.0-1-2 D2	191,00



C500.151	ACCREDIA	Blocchetti singoli 125-200 gr.0-1 D1	114,00
C500.154	ACCREDIA	Blocchetti singoli 225-300 gr.0-1 D1	121,00
C500.155	ACCREDIA	Blocchetti singoli 325-400 gr.0-1 D1	127,00
C500.158	ACCREDIA	Blocchetti singoli 425-650 gr.0-1 D1	134,00

**D1 Verifica in 1 punto centrale - D2 Verifica in 5 punti incl. variazione lunghezza**

C555.151	ACCREDIA	Blocchetti singoli 125-200 gr.0-1 D2	127,00
C555.154	ACCREDIA	Blocchetti singoli 225-300 gr.0-1 D2	138,00
C555.155	ACCREDIA	Blocchetti singoli 325-400 gr.0-1 D2	151,00
C555.158	ACCREDIA	Blocchetti singoli 425-650 gr.0-1 D2	157,00



C514.008	ACCREDIA	Serie 8 blocchetti 25-100 + 125-200 gr.0-1 D1	524,00
C513.008	ACCREDIA	Serie 8 blocchetti 125-500 gr.0-1 D1	640,00

**D1 Verifica in 1 punto centrale - D2 Verifica in 5 punti incl. variazione lunghezza**

C514.558	ACCREDIA	Serie 8 blocchetti 25-100 + 125-200 gr.0-1 D2	651,00
C513.558	ACCREDIA	Serie 8 blocchetti 125-500 gr.0-1 D2	794,00



C515.010	ACCREDIA	Serie 10pz contr.micrometri 0:25 - 2,5-25 gr.1 D1	85,00
C515.011	ACCREDIA	Serie 11pz contr.micrometri 0:25 - 1,4-25 gr.1 D1	93,50

**D1 Verifica in 1 punto centrale - D2 Verifica in 5 punti incl. variazione lunghezza**

C515.510	ACCREDIA	Serie 10pz contr.micrometri 0:25 - 2,5-25 gr.1 D2	99,00
C515.511	ACCREDIA	Serie 11pz contr.micrometri 0:25 - 1,4-25 gr.1 D2	109,00



C516.254	DAKIS	Serie 5pz contr.calibri (3 blocch. + 2 anelli) gr.1 D2	250,00
C516.256	DAKIS	Serie 6pz contr.calibri (4 blocch. + 2 anelli) gr.1 D2	395,00

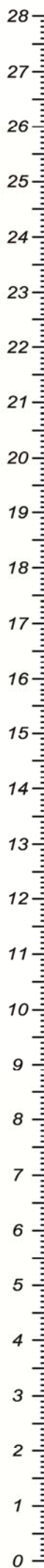

# PREZZI RIFERITI A CERTIFICAZIONI ACCREDIA E RAPPORTI DI TARATURA

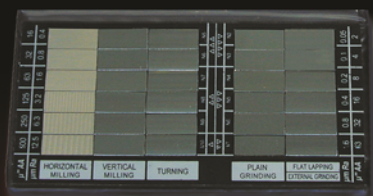

C935.001	ACCREDIA ENTE ITALIANO DI ACCREDITAMENTO	Campioni rugosità 1 area / 1 parametro	150,00
C935.002	ACCREDIA ENTE ITALIANO DI ACCREDITAMENTO	Campioni rugosità 2 aree / 1 parametro per area	191,00
C935.003	ACCREDIA ENTE ITALIANO DI ACCREDITAMENTO	Campioni rugosità 3 aree / 1 parametro per area	228,00
R935.001	R.D.T.	Campioni rugosità 1 area / 1 parametro	119,00
R935.002	R.D.T.	Campioni rugosità 2 aree / 1 parametro per area	156,00
R935.003	R.D.T.	Campioni rugosità 3 aree / 1 parametro per area	219,00



R906.601	R.D.T.	Campioni di durezza scale Rockwell	90,00
R906.605	R.D.T.	Campioni di durezza scale Brinell	90,00
R906.607	R.D.T.	Campioni di durezza scale Vickers oltre 1kg	90,00
R009.600	R.D.T.	Campioni di durezza scale Shore A-D	90,00



C701.714	ACCREDIA ENTE ITALIANO DI ACCREDITAMENTO	Comparatori o tastatori a leva analogici/digitali	92,00
R701.714	R.D.T.	Comparatori o tastatori a leva analogici/digitali	33,00



C897.X01	ACCREDIA ENTE ITALIANO DI ACCREDITAMENTO	Sfere calibrate singole fino a 100	58,00
R897.X01	R.D.T.	Sfere calibrate singole fino a 100	50,00



C724.501	ACCREDIA ENTE ITALIANO DI ACCREDITAMENTO	Spessimetri con comparatore analogico/digitale	92,00
R724.501	R.D.T.	Spessimetri con comparatore analogico/digitale	68,00

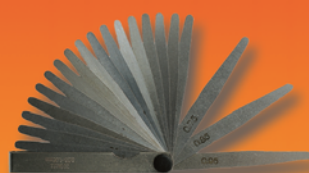

C406.108	ACCREDIA ENTE ITALIANO DI ACCREDITAMENTO	Assortimenti spessimetri a 8 lame L100	85,00
C406.113	ACCREDIA ENTE ITALIANO DI ACCREDITAMENTO	Assortimenti spessimetri a 13 lame L100	109,00
C406.120	ACCREDIA ENTE ITALIANO DI ACCREDITAMENTO	Assortimenti spessimetri a 20 lame L100	132,00

R406.108	R.D.T.	Assortimenti spessimetri a 8 lame L100	39,00
R406.113	R.D.T.	Assortimenti spessimetri a 13 lame L100	51,00
R406.120	R.D.T.	Assortimenti spessimetri a 20 lame L100	62,00



C915.001	ACCREDIA ENTE ITALIANO DI ACCREDITAMENTO	Spessori calibrati singoli	52,00
R915.001	R.D.T.	Spessori calibrati singoli	32,00



R963.X01	R.D.T.	Termometri con sonde K 30/1000°C su 1 punto	38,00
R963.X02	R.D.T.	Termometri con sonde K 30/1000°C su 2 punti	76,00
R963.X03	R.D.T.	Termometri con sonde K 30/1000°C su 3 punti	113,00
R963.X00	R.D.T.	Ogni punto supplementare ai 5 punti cad.	26,00
R963.002	R.D.T.	Ogni sonda agg. alla prima tarata a pari condizioni	65,00



R960.X01	R.D.T.	Termometri a infrarossi 20/300°C su 1 punto	55,00
R960.X02	R.D.T.	Termometri a infrarossi 20/300°C su 2 punti	113,00
R960.X03	R.D.T.	Termometri a infrarossi 20/300°C su 3 punti	169,00
R960.X00	R.D.T.	Ogni punto supplementare ai 5 punti cad.	39,00

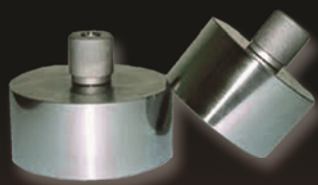

R567.002	R.D.T.	Tamponi di azzeramento (master) fino a Ø50	16,00
R567.050	R.D.T.	Tamponi di azzeramento (master) da Ø50 a 75	23,00
R567.075	R.D.T.	Tamponi di azzeramento (master) da Ø75 a 100	28,00
R567.100	R.D.T.	Tamponi di azzeramento (master) da Ø100 a 150	35,00
R567.150	R.D.T.	Tamponi di azzeramento (master) da Ø150 a 200	44,00
R567.200	R.D.T.	Tamponi di azzeramento (master) da Ø200 a 250	54,00

Verifica standard di 1Ø in corrispondenza della linea di fede sulla mezzeria



R568.002	R.D.T.	Tamponi P oppure NP lisci fino a Ø50 cad.	18,00
R568.050	R.D.T.	Tamponi P oppure NP lisci da Ø50 a 75 cad.	25,00
R568.075	R.D.T.	Tamponi P oppure NP lisci da Ø75 a 100 cad.	33,00
R568.100	R.D.T.	Tamponi P oppure NP lisci da Ø100 a 150 cad.	39,00
R568.150	R.D.T.	Tamponi P oppure NP lisci da Ø150 a 200 cad.	48,00
R568.200	R.D.T.	Tamponi P oppure NP lisci da Ø200 a 250 cad.	58,00

Verifica intermedia di 3Ø a 3 altezze diverse (3 totali)



R575.023	R.D.T.	Tamponi lisci P/NP fino a Ø50 cad.	20,00
R575.503	R.D.T.	Tamponi lisci P/NP da Ø50 a 75 cad.	27,00
R575.753	R.D.T.	Tamponi lisci P/NP da Ø75 a 100 cad.	35,00
R576.003	R.D.T.	Tamponi lisci P/NP da Ø100 a 150 cad.	42,00
R576.503	R.D.T.	Tamponi lisci P/NP da Ø150 a 200 cad.	52,00
R577.003	R.D.T.	Tamponi lisci P/NP da Ø200 a 250 cad.	64,00

Verifica intermedia di 3Ø a 3 altezze diverse (6 misure totali)



C575.061	ACCREDIA	Tamponi lisci P/NP singoli	richiesta
C575.06X	R.D.T.	Come sopra oltre 5pz fino a 10pz ed oltre 10pz	richiesta

Verifica completa di 3Ø a 3 altezze diverse + ovalità 3Ø a 90° (12 totali)



C569.002	ACCREDIA	Anelli filettati da Ø5 a Ø120 cad.	81,00
R569.003	R.D.T.	Anelli filettati da Ø3 a Ø20 cad.	18,00
R569.020	R.D.T.	Anelli filettati da Ø20 a Ø50 cad.	23,00
R569.050	R.D.T.	Anelli filettati da Ø50 a Ø75 cad.	30,00
R569.075	R.D.T.	Anelli filettati da Ø75 a Ø150 cad.	34,00



C572.002	ACCREDIA	Tamponi filettati P/NP da Ø5 a Ø120 cad.	81,00
R572.003	R.D.T.	Tamponi filettati P/NP da Ø3 a Ø20 cad.	26,00
R572.020	R.D.T.	Tamponi filettati P/NP da Ø20 a Ø50 cad.	30,00
R572.050	R.D.T.	Tamponi filettati P/NP da Ø50 a Ø75 cad.	34,00
R572.075	R.D.T.	Tamponi filettati P/NP da Ø75 a Ø100 cad.	41,00



C009.648	ACCREDIA	Preset altezza 50/100 contatto 1 punto centrale	138,00
R009.648	R.D.T.	Preset altezza 50/100 contatto 1 punto centrale	59,00



R003.066	R.D.T.	Rapportatore d'angolo con 1 asta	99,00
R003.995	R.D.T.	Rapportatore d'angolo digitale con 1 asta	107,00

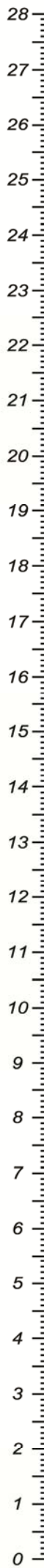



**Strumenti di Misura  
Apparecchi di Controllo  
Certificazioni Accredia**



**VOGEL srl**

**dal 1990**

*Azienda gestita con Microsoft Dynamics NAV*

**VOGEL srl.**

Via A. Vespucci, 3/5  
25024 LENO (BS)

CF e P.IVA  
01594040980

Tel 030 906591 - 8 linee r.a.

Fax 030 9067763

WhatsApp 392 7755222

Sito [www.vogel.it](http://www.vogel.it)

Mail [Info@vogel.it](mailto:Info@vogel.it)



Vogel srl



*Questa Promozione Vi è stata presentata da:*